

QUADRA

$R0^\circ$

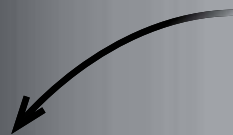

$R0^\circ$



$R0^\circ$

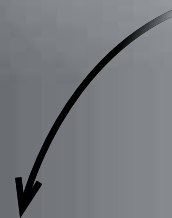

vittinox

Vasche/Lavelli
Modello Quadra e QR10
Bowls /Sinks Welded
“Quadra” and “QR10”

QR10

$R10^\circ$

$R0^\circ$

$R10^\circ$

Vasche/Lavelli Modello Quadra e QR10 a Saldare

Welded "Quadra" "QR10" Bowls/Sinks

Realizzate in acciaio INOX AISI 304, 18-10 con pilettona 3" 1/2 in acciaio INOX AISI 304, 18-10 con troppo pieno.

Made of AISI 304, 18-10 stainless steel with 3" 1/2 AISI 304, 18-10 stainless steel sink drain and overflow.

Compreso foro e saldatura / Hole and welding included

Lavelli 1 vasca

1-bowl sink

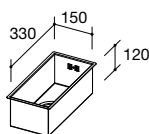

CODICE/code	DIMENSIONI/size	PREZZO/price
-------------	-----------------	--------------

1100101 Quadra	150x330x120 mm	
-----------------------	----------------	--

COMPRESO FORO E SALDATURA · HOLE AND WELDING INCLUDED
LAVORAZIONE DI SALDATURA E PULITURA SU PIANO LUCIDO A SPECCHIO + € 65,00
WELDING AND CLEANING ON MIRROR- FINISHED TOPS + € 65,00

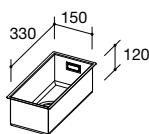

CODICE/code	DIMENSIONI/size	PREZZO/price
-------------	-----------------	--------------

1151201 QR10	150x330x120 mm	
---------------------	----------------	--

COMPRESO FORO E SALDATURA · HOLE AND WELDING INCLUDED
LAVORAZIONE DI SALDATURA E PULITURA SU PIANO LUCIDO A SPECCHIO + € 65,00
WELDING AND CLEANING ON MIRROR- FINISHED TOPS + € 65,00

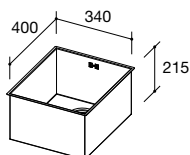

CODICE/code	DIMENSIONI/size	PREZZO/price
-------------	-----------------	--------------

1100201 Quadra	340x400x215 mm	
-----------------------	----------------	--

COMPRESO FORO E SALDATURA · HOLE AND WELDING INCLUDED
LAVORAZIONE DI SALDATURA E PULITURA SU PIANO LUCIDO A SPECCHIO + € 75,00
WELDING AND CLEANING ON MIRROR- FINISHED TOPS + € 75,00

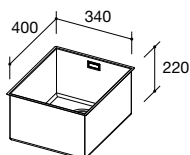

CODICE/code	DIMENSIONI/size	PREZZO/price
-------------	-----------------	--------------

1150201 QR10	340x400x220 mm	
---------------------	----------------	--

COMPRESO FORO E SALDATURA · HOLE AND WELDING INCLUDED
LAVORAZIONE DI SALDATURA E PULITURA SU PIANO LUCIDO A SPECCHIO + € 75,00
WELDING AND CLEANING ON MIRROR- FINISHED TOPS + € 75,00

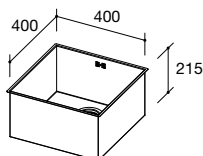

CODICE/code	DIMENSIONI/size	PREZZO/price
-------------	-----------------	--------------

1100301 Quadra	400x400x215 mm	
-----------------------	----------------	--

COMPRESO FORO E SALDATURA · HOLE AND WELDING INCLUDED
LAVORAZIONE DI SALDATURA E PULITURA SU PIANO LUCIDO A SPECCHIO + € 75,00
WELDING AND CLEANING ON MIRROR- FINISHED TOPS + € 75,00

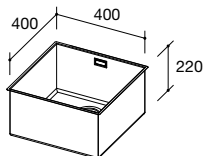

CODICE/code	DIMENSIONI/size	PREZZO/price
-------------	-----------------	--------------

1150301 QR10	400x400x220 mm	
---------------------	----------------	--

COMPRESO FORO E SALDATURA · HOLE AND WELDING INCLUDED
LAVORAZIONE DI SALDATURA E PULITURA SU PIANO LUCIDO A SPECCHIO + € 75,00
WELDING AND CLEANING ON MIRROR- FINISHED TOPS + € 75,00

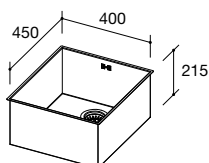

CODICE/code	DIMENSIONI/size	PREZZO/price
-------------	-----------------	--------------

1100401 Quadra	400x450x215 mm	
-----------------------	----------------	--

COMPRESO FORO E SALDATURA · HOLE AND WELDING INCLUDED
LAVORAZIONE DI SALDATURA E PULITURA SU PIANO LUCIDO A SPECCHIO + € 75,00
WELDING AND CLEANING ON MIRROR- FINISHED TOPS + € 75,00

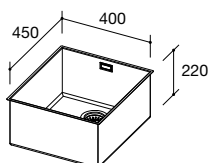

CODICE/code	DIMENSIONI/size	PREZZO/price
-------------	-----------------	--------------

1150401 QR10	400x450x220 mm	
---------------------	----------------	--

COMPRESO FORO E SALDATURA · HOLE AND WELDING INCLUDED
LAVORAZIONE DI SALDATURA E PULITURA SU PIANO LUCIDO A SPECCHIO + € 75,00
WELDING AND CLEANING ON MIRROR- FINISHED TOPS + € 75,00

Vasche/Lavelli Modello Quadra e QR10 a Saldare

Welded "Quadra" "QR10" Bowls/Sinks

Realizzate in acciaio INOX AISI 304, 18-10 con pilettona 3" 1/2 in acciaio INOX AISI 304, 18-10 con troppo pieno.

Made of AISI 304, 18-10 stainless steel with 3" 1/2 AISI 304, 18-10 stainless steel sink drain and overflow.

Compreso foro e saldatura / Hole and welding included

Lavelli 1 vasca

1-bowl sink

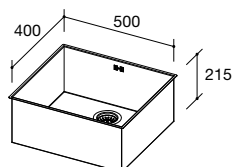

CODICE/code	DIMENSIONI/size	PREZZO/price
-------------	-----------------	--------------

1100501 Quadra 500x400x215 mm

COMPRESO FORO E SALDATURA · HOLE AND WELDING INCLUDED
LAVORAZIONE DI SALDATURA E PULITURA SU PIANO LUCIDO A SPECCHIO + € 85,00
WELDING AND CLEANING ON MIRROR- FINISHED TOPS + € 85,00

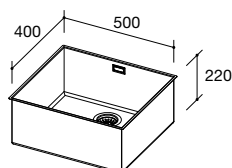

CODICE/code	DIMENSIONI/size	PREZZO/price
-------------	-----------------	--------------

1150501 QR10 500x400x220 mm

COMPRESO FORO E SALDATURA · HOLE AND WELDING INCLUDED
LAVORAZIONE DI SALDATURA E PULITURA SU PIANO LUCIDO A SPECCHIO + € 85,00
WELDING AND CLEANING ON MIRROR- FINISHED TOPS + € 85,00

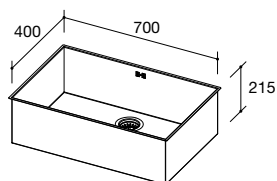

CODICE/code	DIMENSIONI/size	PREZZO/price
-------------	-----------------	--------------

1101001 Quadra 700x400x215 mm

COMPRESO FORO E SALDATURA · HOLE AND WELDING INCLUDED
LAVORAZIONE DI SALDATURA E PULITURA SU PIANO LUCIDO A SPECCHIO + € 110,00
WELDING AND CLEANING ON MIRROR- FINISHED TOPS + € 110,00

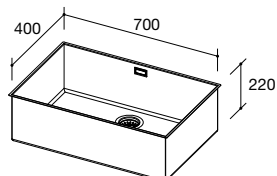

CODICE/code	DIMENSIONI/size	PREZZO/price
-------------	-----------------	--------------

1151001 QR10 700x400x220 mm

COMPRESO FORO E SALDATURA · HOLE AND WELDING INCLUDED
LAVORAZIONE DI SALDATURA E PULITURA SU PIANO LUCIDO A SPECCHIO + € 110,00
WELDING AND CLEANING ON MIRROR- FINISHED TOPS + € 110,00

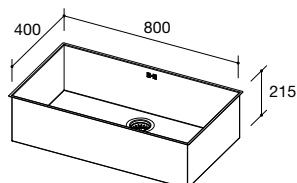

CODICE/code	DIMENSIONI/size	PREZZO/price
-------------	-----------------	--------------

1101101 Quadra 800x400x215 mm

COMPRESO FORO E SALDATURA · HOLE AND WELDING INCLUDED
LAVORAZIONE DI SALDATURA E PULITURA SU PIANO LUCIDO A SPECCHIO + € 120,00
WELDING AND CLEANING ON MIRROR- FINISHED TOPS + € 120,00

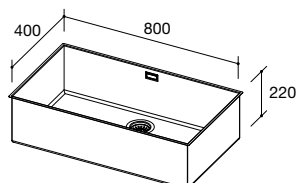

CODICE/code	DIMENSIONI/size	PREZZO/price
-------------	-----------------	--------------

1151101 QR10 800x400x220 mm

COMPRESO FORO E SALDATURA · HOLE AND WELDING INCLUDED
LAVORAZIONE DI SALDATURA E PULITURA SU PIANO LUCIDO A SPECCHIO + € 120,00
WELDING AND CLEANING ON MIRROR- FINISHED TOPS + € 120,00

Vasche/Lavelli Modello Quadra e QR10 a Saldare

Welded "Quadra" "QR10" Bowls/Sinks

Realizzate in acciaio INOX AISI 304, 18-10 con pilettona 3" 1/2 in acciaio INOX AISI 304, 18-10 con troppo pieno.

Made of AISI 304, 18-10 stainless steel with 3" 1/2 AISI 304, 18-10 stainless steel sink drain and overflow.

Compreso foro e saldatura / Hole and welding included

Lavelli 1 vasca + gocciolatoio

1-bowl sinks w/ drainer

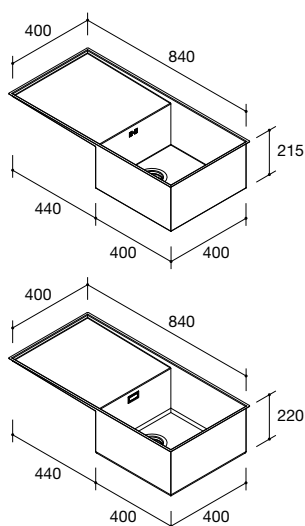

CODICE/code	DIMENSIONI/size	PREZZO/price
-------------	-----------------	--------------

1101201 Quadra	840x400x215 mm / gocc. DX/SX	
-----------------------	------------------------------	--

COMPRESO FORO E SALDATURA - HOLE AND WELDING INCLUDED
LAVORAZIONE DI SALDATURA E PULITURA SU PIANO LUCIDO A SPECCHIO + € 120,00
WELDING AND CLEANING ON MIRROR- FINISHED TOPS + € 120,00

CODICE/code	DIMENSIONI/size	PREZZO/price
-------------	-----------------	--------------

1151201 QR10	840x400x220 mm / gocc. DX/SX	
---------------------	------------------------------	--

COMPRESO FORO E SALDATURA - HOLE AND WELDING INCLUDED
LAVORAZIONE DI SALDATURA E PULITURA SU PIANO LUCIDO A SPECCHIO + € 120,00
WELDING AND CLEANING ON MIRROR- FINISHED TOPS + € 120,00

Lavelli 2 vasche

2-bowl sinks

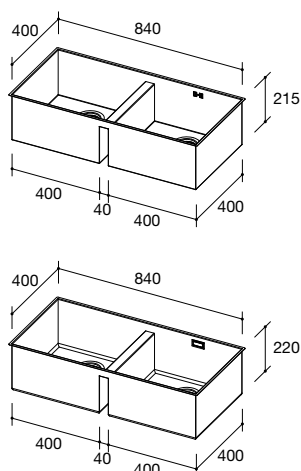

CODICE/code	DIMENSIONI/size	PREZZO/price
-------------	-----------------	--------------

1101301 Quadra	840x400x215 mm	-----
-----------------------	----------------	-------

COMPRESO FORO E SALDATURA - HOLE AND WELDING INCLUDED
LAVORAZIONE DI SALDATURA E PULITURA SU PIANO LUCIDO A SPECCHIO + € 120,00
WELDING AND CLEANING ON MIRROR- FINISHED TOPS + € 120,00

CODICE/code	DIMENSIONI/size	PREZZO/price
-------------	-----------------	--------------

1151301 QR10	840x400x220 mm	
---------------------	----------------	--

COMPRESO FORO E SALDATURA - HOLE AND WELDING INCLUDED
LAVORAZIONE DI SALDATURA E PULITURA SU PIANO LUCIDO A SPECCHIO + € 120,00
WELDING AND CLEANING ON MIRROR- FINISHED TOPS + € 120,00

Lavelli 2 vasche + gocciolatoio

2-bowl sinks w/ drainer

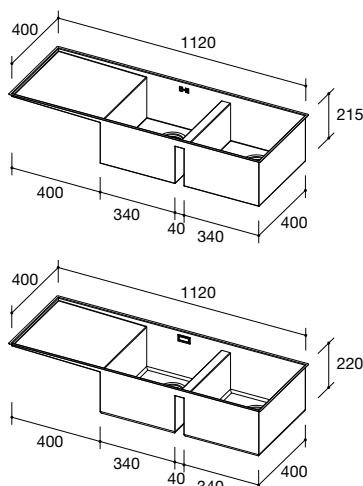

CODICE/code	DIMENSIONI/size	PREZZO/price
-------------	-----------------	--------------

1101401 Quadra	1120x400x215 mm / gocc. DX	-----
-----------------------	----------------------------	-------

1101501 Quadra	1120x400x215 mm / gocc. SX	-----
-----------------------	----------------------------	-------

COMPRESO FORO E SALDATURA - HOLE AND WELDING INCLUDED
LAVORAZIONE DI SALDATURA E PULITURA SU PIANO LUCIDO A SPECCHIO + € 180,00
WELDING AND CLEANING ON MIRROR- FINISHED TOPS + € 180,00

CODICE/code	DIMENSIONI/size	PREZZO/price
-------------	-----------------	--------------

1151401 QR10	1120x400x220 mm / gocc. DX	
---------------------	----------------------------	--

1151501 QR10	1120x400x220 mm / gocc. SX	
---------------------	----------------------------	--

COMPRESO FORO E SALDATURA - HOLE AND WELDING INCLUDED
LAVORAZIONE DI SALDATURA E PULITURA SU PIANO LUCIDO A SPECCHIO + € 180,00
WELDING AND CLEANING ON MIRROR- FINISHED TOPS + € 180,00

Modello Quadra e QR10 a saldare

Lavelli con scivolo inclinato a scomparsa

Welded "Quadra" "QR10"

Sinks with inclined hidden chute

Compreso foro e saldatura / Hole and welding included

Saldati su Top inox Sp 12/10 / Saldati su Top inox Sp 12/10 · Aisi 304 Sp 12/10 / Aisi 304 18/10 Sp 12/10
Lavello inox Sp 12/10 · Aisi 304 Sp 12/10 / Aisi 304 18/10 Sp 12/10

Lavelli 1 vasca + gocciolatoio

1-bowl sinks w/ drainer

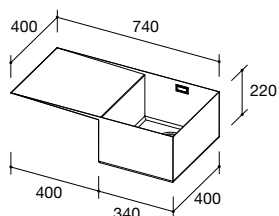
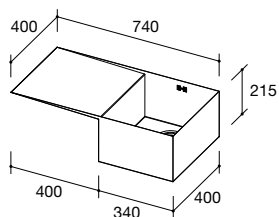

CODICE/code	DIMENSIONI/size	PREZZO/price
1102101 Quadra	vasca/bowl: 340x400x215 mm lavello/sink: 740x400 mm / gocc. DX	
1102201 Quadra	vasca/bowl: 340x400x215 mm lavello/sink: 740x400 mm / gocc. SX	

COMPRESO FORO E SALDATURA · HOLE AND WELDING INCLUDED
LAVORAZIONE DI SALDATURA E PULITURA SU PIANO LUCIDO A SPECCHIO + € 150,00
WELDING AND CLEANING ON MIRROR- FINISHED TOPS + € 150,00

CODICE/code	DIMENSIONI/size	PREZZO/price
1152101 QR10	vasca/bowl: 340x400x220 mm lavello/sink: 740x400 mm / gocc. DX	
1152201 QR10	vasca/bowl: 340x400x220 mm lavello/sink: 740x400 mm / gocc. SX	

COMPRESO FORO E SALDATURA · HOLE AND WELDING INCLUDED
LAVORAZIONE DI SALDATURA E PULITURA SU PIANO LUCIDO A SPECCHIO + € 150,00
WELDING AND CLEANING ON MIRROR- FINISHED TOPS + € 150,00

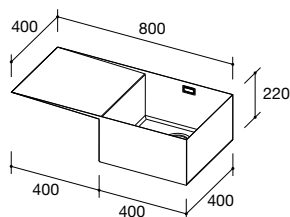
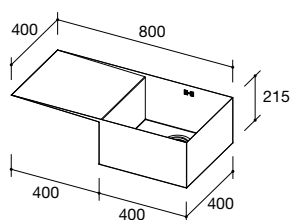

CODICE/code	DIMENSIONI/size	PREZZO/price
1102301 Quadra	vasca/bowl: 400x400x215 mm lavello/sink: 800x400 mm / gocc. DX	
1102401 Quadra	vasca/bowl: 400x400x215 mm lavello/sink: 800x400 mm / gocc. SX	

COMPRESO FORO E SALDATURA · HOLE AND WELDING INCLUDED
LAVORAZIONE DI SALDATURA E PULITURA SU PIANO LUCIDO A SPECCHIO + € 150,00
WELDING AND CLEANING ON MIRROR- FINISHED TOPS + € 150,00

CODICE/code	DIMENSIONI/size	PREZZO/price
1152301 QR10	vasca/bowl: 400x400x220 mm lavello/sink: 800x400 mm / gocc. DX	
1152401 QR10	vasca/bowl: 400x400x220 mm lavello/sink: 800x400 mm / gocc. SX	

COMPRESO FORO E SALDATURA · HOLE AND WELDING INCLUDED
LAVORAZIONE DI SALDATURA E PULITURA SU PIANO LUCIDO A SPECCHIO + € 150,00
WELDING AND CLEANING ON MIRROR- FINISHED TOPS + € 150,00

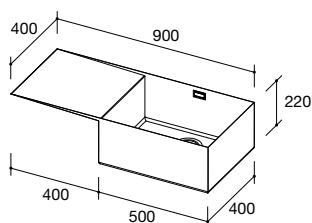
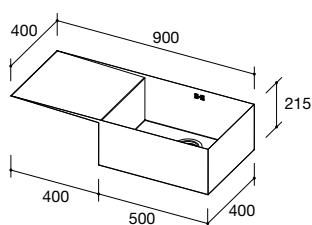

CODICE/code	DIMENSIONI/size	PREZZO/price
1102501 Quadra	vasca/bowl: 500x400x215 mm lavello/sink: 900x400 mm / gocc. DX	
1102601 Quadra	vasca/bowl: 500x400x215 mm lavello/sink: 900x400 mm / gocc. SX	

COMPRESO FORO E SALDATURA · HOLE AND WELDING INCLUDED
LAVORAZIONE DI SALDATURA E PULITURA SU PIANO LUCIDO A SPECCHIO + € 180,00
WELDING AND CLEANING ON MIRROR- FINISHED TOPS + € 180,00

CODICE/code	DIMENSIONI/size	PREZZO/price
1152501 QR10	vasca/bowl: 500x400x220 mm lavello/sink: 900x400 mm / gocc. DX	
1152601 QR10	vasca/bowl: 500x400x220 mm lavello/sink: 900x400 mm / gocc. SX	

COMPRESO FORO E SALDATURA · HOLE AND WELDING INCLUDED
LAVORAZIONE DI SALDATURA E PULITURA SU PIANO LUCIDO A SPECCHIO + € 180,00
WELDING AND CLEANING ON MIRROR- FINISHED TOPS + € 180,00

Modello Quadra e QR10 a saldare Lavelli con scivolo inclinato a scomparsa

Welded "Quadra" "QR10"

Sinks with inclined hidden chute

Compreso foro e saldatura / Hole and welding included

Saldati su Top inox Sp 12/10 / Saldati su Top inox Sp 12/10 · Aisi 304 Sp 12/10 / Aisi 304 18/10 Sp 12/10
Lavello inox Sp 12/10 · Aisi 304 Sp 12/10 / Aisi 304 18/10 Sp 12/10

Lavelli 2 vasche + gocciolatoio

2-bowl sinks w/ drainer

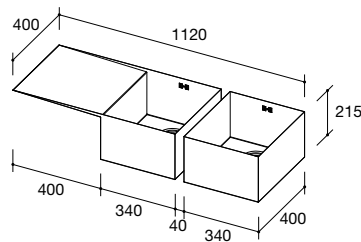

CODICE/code	DIMENSIONI/size	PREZZO/price
1102701 Quadra	2 vasche/bowls: 340x400x215 mm lavello/sink: 1120x400 mm/ gocc. DX	
1102801 Quadra	2 vasche/bowls: 340x400x215 mm lavello/sink: 1120x400 mm/ gocc. SX	

COMPRESO FORO E SALDATURA · HOLE AND WELDING INCLUDED
LAVORAZIONE DI SALDATURA E PULITURA SU PIANO LUCIDO A SPECCHIO + € 180,00
WELDING AND CLEANING ON MIRROR· FINISHED TOPS + € 180,00

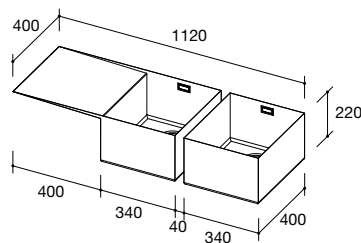

CODICE/code	DIMENSIONI/size	PREZZO/price
1152701 QR10	2 vasche/bowls: 340x400x220 mm lavello/sink: 1120x400 mm/ gocc. DX	
1152801 QR10	2 vasche/bowls: 340x400x220 mm lavello/sink: 1120x400 mm/ gocc. SX	

COMPRESO FORO E SALDATURA · HOLE AND WELDING INCLUDED
LAVORAZIONE DI SALDATURA E PULITURA SU PIANO LUCIDO A SPECCHIO + € 180,00
WELDING AND CLEANING ON MIRROR· FINISHED TOPS + € 180,00

Vasche S-Line modello Quadra e QR10 a saldare ed accessori

Welded S-Line "Quadra", "QR10" sinks and accessories

Compreso foro e saldatura / Hole and welding included

Lavelli 1 vasca

1-bowl sink

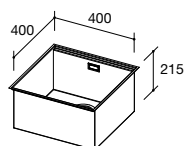

CODICE/code	DIMENSIONI/size	PREZZO/price
-------------	-----------------	--------------

1154101 Quadra	400x400x215 mm	
-----------------------	----------------	--

COMPRESO FORO E SALDATURA · HOLE AND WELDING INCLUDED
LAVORAZIONE DI SALDATURA E PULITURA SU PIANO LUCIDO A SPECCHIO + € 85,00
WELDING AND CLEANING ON MIRROR- FINISHED TOPS + € 85,00

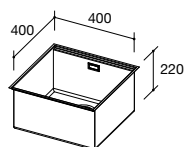

CODICE/code	DIMENSIONI/size	PREZZO/price
-------------	-----------------	--------------

1155101 QR10	400x400x220 mm	
---------------------	----------------	--

COMPRESO FORO E SALDATURA · HOLE AND WELDING INCLUDED
LAVORAZIONE DI SALDATURA E PULITURA SU PIANO LUCIDO A SPECCHIO + € 85,00
WELDING AND CLEANING ON MIRROR- FINISHED TOPS + € 85,00

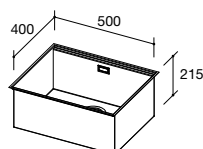
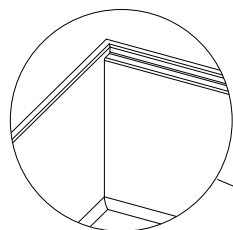

CODICE/code	DIMENSIONI/size	PREZZO/price
-------------	-----------------	--------------

1154201 Quadra	500x400x215 mm	
-----------------------	----------------	--

COMPRESO FORO E SALDATURA · HOLE AND WELDING INCLUDED
LAVORAZIONE DI SALDATURA E PULITURA SU PIANO LUCIDO A SPECCHIO + € 110,00
WELDING AND CLEANING ON MIRROR- FINISHED TOPS + € 110,00

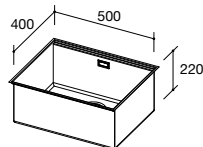

CODICE/code	DIMENSIONI/size	PREZZO/price
-------------	-----------------	--------------

1155201 QR10	500x400x220 mm	
---------------------	----------------	--

COMPRESO FORO E SALDATURA · HOLE AND WELDING INCLUDED
LAVORAZIONE DI SALDATURA E PULITURA SU PIANO LUCIDO A SPECCHIO + € 110,00
WELDING AND CLEANING ON MIRROR- FINISHED TOPS + € 110,00

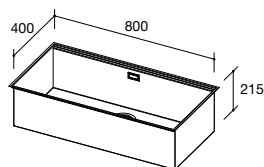

CODICE/code	DIMENSIONI/size	PREZZO/price
-------------	-----------------	--------------

1154301 Quadra	800x400x215 mm	
-----------------------	----------------	--

COMPRESO FORO E SALDATURA · HOLE AND WELDING INCLUDED
LAVORAZIONE DI SALDATURA E PULITURA SU PIANO LUCIDO A SPECCHIO + € 120,00
WELDING AND CLEANING ON MIRROR- FINISHED TOPS + € 120,00

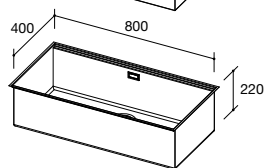

CODICE/code	DIMENSIONI/size	PREZZO/price
-------------	-----------------	--------------

1155301 QR10	800x400x220 mm	
---------------------	----------------	--

COMPRESO FORO E SALDATURA · HOLE AND WELDING INCLUDED
LAVORAZIONE DI SALDATURA E PULITURA SU PIANO LUCIDO A SPECCHIO + € 120,00
WELDING AND CLEANING ON MIRROR- FINISHED TOPS + € 120,00

Colapasta

Colapasta

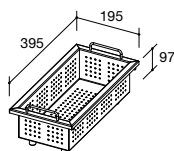

CODICE/code	DIMENSIONI/size	PREZZO/price
-------------	-----------------	--------------

1311201	195x395x97 mm	
----------------	---------------	--

Vassoio

Vassoio

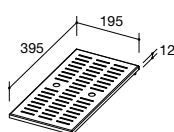

CODICE/code	DIMENSIONI/size	PREZZO/price
-------------	-----------------	--------------

1311301	195x395x12 mm	
----------------	---------------	--

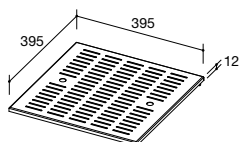

CODICE/code	DIMENSIONI/size	PREZZO/price
-------------	-----------------	--------------

1311401	395x395x12 mm	
----------------	---------------	--





vittinox

Vasche/Lavelli
Modello Round
Bowls /Sinks
Welded “Round”

Vasche/Lavelli Modello Modello Round a Saldare Welded "Round" Bowls/Sinks

Realizzate in acciaio INOX AISI 304, 18-10
con pilettono 3" 1/2 in acciaio INOX AISI 304, 18-10 con troppo pieno.

Made of AISI 304, 18-10 stainless steel with 3" 1/2 AISI 304, 18-10 stainless steel sink drain and overflow.

Compreso foro e saldatura / Hole and welding included

Lavelli 1 vasca 1-bowl sink

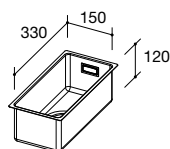

CODICE/code	DIMENSIONI/size	PREZZO/price
-------------	-----------------	--------------

1103101	150x330x120 mm	
----------------	-----------------------	--

COMPRESO FORO E SALDATURA · HOLE AND WELDING INCLUDED
LAVORAZIONE DI SALDATURA E PULITURA SU PIANO LUCIDO A SPECCHIO + € 65,00
WELDING AND CLEANING ON MIRROR- FINISHED TOPS + € 65,00

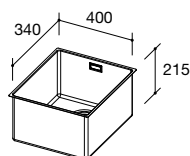

CODICE/code	DIMENSIONI/size	PREZZO/price
-------------	-----------------	--------------

1103201	340x400x215 mm	
----------------	-----------------------	--

COMPRESO FORO E SALDATURA · HOLE AND WELDING INCLUDED
LAVORAZIONE DI SALDATURA E PULITURA SU PIANO LUCIDO A SPECCHIO + € 75,00
WELDING AND CLEANING ON MIRROR- FINISHED TOPS + € 75,00

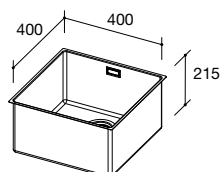

CODICE/code	DIMENSIONI/size	PREZZO/price
-------------	-----------------	--------------

1103301	400x400x215 mm	
----------------	-----------------------	--

COMPRESO FORO E SALDATURA · HOLE AND WELDING INCLUDED
LAVORAZIONE DI SALDATURA E PULITURA SU PIANO LUCIDO A SPECCHIO + € 75,00
WELDING AND CLEANING ON MIRROR- FINISHED TOPS + € 75,00

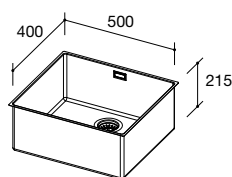

CODICE/code	DIMENSIONI/size	PREZZO/price
-------------	-----------------	--------------

1103401	500x400x215 mm	
----------------	-----------------------	--

COMPRESO FORO E SALDATURA · HOLE AND WELDING INCLUDED
LAVORAZIONE DI SALDATURA E PULITURA SU PIANO LUCIDO A SPECCHIO + € 75,00
WELDING AND CLEANING ON MIRROR- FINISHED TOPS + € 75,00

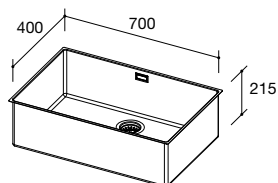

CODICE/code	DIMENSIONI/size	PREZZO/price
-------------	-----------------	--------------

1103801	700x400x215 mm	
----------------	-----------------------	--

COMPRESO FORO E SALDATURA · HOLE AND WELDING INCLUDED
LAVORAZIONE DI SALDATURA E PULITURA SU PIANO LUCIDO A SPECCHIO + € 110,00
WELDING AND CLEANING ON MIRROR- FINISHED TOPS + € 110,00

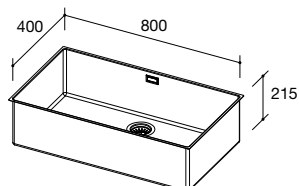

CODICE/code	DIMENSIONI/size	PREZZO/price
-------------	-----------------	--------------

1103501	800x400x215 mm	
----------------	-----------------------	--

COMPRESO FORO E SALDATURA · HOLE AND WELDING INCLUDED
LAVORAZIONE DI SALDATURA E PULITURA SU PIANO LUCIDO A SPECCHIO + € 120,00
WELDING AND CLEANING ON MIRROR- FINISHED TOPS + € 120,00

Modello Round a saldare

Lavelli con scivolo inclinato a scomparsa

Welded "Round"

Sinks with inclined hidden chute

Compreso foro e saldatura / Hole and welding included

Saldati su Top inox Sp 12/10 / Saldati su Top inox Sp 12/10 · Aisi 304 Sp 12/10 / Aisi 304 18/10 Sp 12/10
Lavello inox Sp 12/10 · Aisi 304 Sp 12/10

Lavelli 1 vasca + gocciolatoio

1-bowl sinks w/ drainer

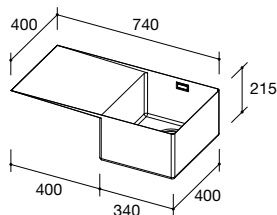

CODICE/code	DIMENSIONI/size	PREZZO/price
1104101	vasca/bowl: 340x400x215 mm lavello/sink: 740x400 mm / gocc. DX	
1104201	vasca/bowl: 340x400x215 mm lavello/sink: 740x400 mm / gocc. SX	

COMPRESO FORO E SALDATURA · HOLE AND WELDING INCLUDED
LAVORAZIONE DI SALDATURA E PULITURA SU PIANO LUCIDO A SPECCHIO + € 150,00
WELDING AND CLEANING ON MIRROR-FINISHED TOPS + € 150,00

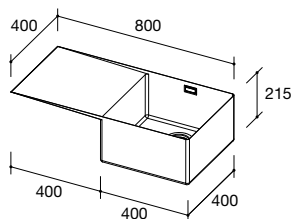

CODICE/code	DIMENSIONI/size	PREZZO/price
1104301	vasca/bowl: 400x400x215 mm lavello/sink: 800x400 mm / gocc. DX	
1104401	vasca/bowl: 400x400x215 mm lavello/sink: 800x400 mm / gocc. SX	

COMPRESO FORO E SALDATURA · HOLE AND WELDING INCLUDED
LAVORAZIONE DI SALDATURA E PULITURA SU PIANO LUCIDO A SPECCHIO + € 150,00
WELDING AND CLEANING ON MIRROR-FINISHED TOPS + € 150,00

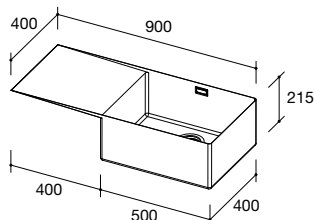

CODICE/code	DIMENSIONI/size	PREZZO/price
1104501	vasca/bowl: 500x400x215 mm lavello/sink: 900x400 mm / gocc. DX	
1104601	vasca/bowl: 500x400x215 mm lavello/sink: 900x400 mm / gocc. SX	

COMPRESO FORO E SALDATURA · HOLE AND WELDING INCLUDED
LAVORAZIONE DI SALDATURA E PULITURA SU PIANO LUCIDO A SPECCHIO + € 150,00
WELDING AND CLEANING ON MIRROR-FINISHED TOPS + € 150,00

Lavelli 2 vasche + gocciolatoio

2-bowl sinks w/ drainer

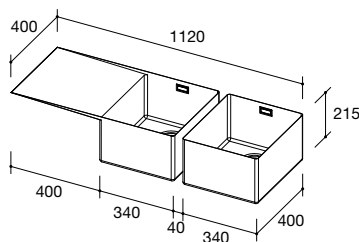

CODICE/code	DIMENSIONI/size	PREZZO/price
1104701	2 vasche/bowls: 340x400x215 mm lavello/sink: 1120x400 mm / gocc. DX	
1104801	2 vasche/bowls: 340x400x215 mm lavello/sink: 1120x400 mm / gocc. SX	

COMPRESO FORO E SALDATURA · HOLE AND WELDING INCLUDED
LAVORAZIONE DI SALDATURA E PULITURA SU PIANO LUCIDO A SPECCHIO + € 180,00
WELDING AND CLEANING ON MIRROR-FINISHED TOPS + € 180,00

Vasche stampate

Moulded bowls



Realizzate in acciaio INOX AISI 304,
18-10 con pilettona 3" 1/2 in acciaio INOX AISI 304, 18-10 con troppo pieno.

Made of AISI 304, 18-10 stainless steel with 3" 1/2 AISI 304, 18-10 stainless steel sink drain and overflow.

Compreso foro e saldatura / Hole and welding included

Lavelli 1 vasca 1-bowl sinks



CODICE/code	DIMENSIONI/size	PREZZO/price
1105101	145x335x120 (LxPxH) - R angolo 50 mm	
1105201	150x300x150 (LxPxH) - Foster 1300/068	

COMPRESO FORO E SALDATURA - HOLE AND WELDING INCLUDED
LAVORAZIONE DI SALDATURA E PULITURA SU PIANO LUCIDO A SPECCHIO + € 65,00
WELDING AND CLEANING ON MIRROR-FINISHED TOPS + € 65,00

Lavelli 1 vasca 1-bowl sinks



CODICE/code	DIMENSIONI/size	PREZZO/price
1106101	340x390x200 R 93,5 mm Jollynox	
1106201	400x400x200 R 60 mm Ronda	
1106301	500x400x200 R 100 mm Inox Piave	
1106401	300x340x200 R51 Franke GAX 110-30	
1106501	340x400x200 R 92,5 Franke AMX 110-34	
1106601	450x400x190 R74 Franke GAX 110-45	
1106701	450x400x175 R94 Foster 1811/050	
1108101	340x400x200 R60 Foster 1117/861 DX*	
1108201	340x400x200 R60 Foster 1117/862 SX**	
1108301	400x400x200 R60 Foster 1114/861 DX*	
1108401	400x400x200 R60 Foster 1114/862 SX**	
1108501	500x400x200 R60 Foster 1116/861 DX*	
1108601	500x400x200 R60 Foster 1116/862 SX**	
1108701	340x400x195 R15 Foster KE 2153/860	
1108801	450x400x195 R15 Foster KE 2154/860	
1108901	500x400x195 R15 Foster KE 2155/860	

COMPRESO FORO E SALDATURA - HOLE AND WELDING INCLUDED -
LAVORAZIONE DI SALDATURA E PULITURA SU PIANO LUCIDO A SPECCHIO + € 65,00
WELDING AND CLEANING ON MIRROR-FINISHED TOPS + € 65,00
* DX = SCARICO A DESTRA · DX RIGHT DRAIN - ** SX = SCARICO A SINISTRA · SX LEFT DRAIN

Lavelli 1 vasca 1-bowl sinks



CODICE/code	DIMENSIONI/size	PREZZO/price
1107101	Ø 420 x H 180 mm Mori	
1107201	Ø 380 x H 180 mm Mori	

COMPRESO FORO E SALDATURA - HOLE AND WELDING INCLUDED
LAVORAZIONE DI SALDATURA E PULITURA SU PIANO LUCIDO A SPECCHIO + € 65,00
WELDING AND CLEANING ON MIRROR-FINISHED TOPS + € 65,00

Lavelli FOSTER

Foster sinks



Realizzate in acciaio INOX AISI 304, 18-10 con pilettoni 3" 1/2 in acciaio INOX AISI 304, 18-10 con troppo pieno.

Made of AISI 304, 18-10 stainless steel with 3" 1/2 AISI 304, 18-10 stainless steel sink drain and overflow.

Compreso foro e saldatura / Hole and welding included

Lavelli 2 vasche 2-bowl sinks

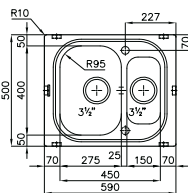

mod. 1510/061-2 DX/SX S. BIG BOWL



CODICE/code DIMENSIONI/size PREZZO/price

1122001 590x500 mm / vasca grande DX

1122101 590x500 mm / vasca grande SX

COMPRESO FORO E SALDATURA · HOLE AND WELDING INCLUDED
LAVORAZIONE DI SALDATURA E PULITURA SU PIANO LUCIDO A SPECCHIO + € 120,00
WELDING AND CLEANING ON MIRROR-FINISHED TOPS + € 120,00

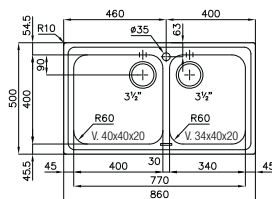

mod. 1382/062 S.3000



CODICE/code DIMENSIONI/size PREZZO/price

1120201 860x500 mm

COMPRESO FORO E SALDATURA · HOLE AND WELDING INCLUDED
LAVORAZIONE DI SALDATURA E PULITURA SU PIANO LUCIDO A SPECCHIO + € 120,00
WELDING AND CLEANING ON MIRROR-FINISHED TOPS + € 120,00

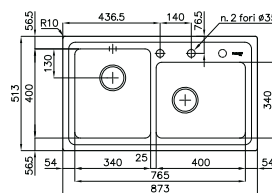

mod. 4385/050 S.4000



CODICE/code DIMENSIONI/size PREZZO/price

1122201 873x513 mm

COMPRESO FORO E SALDATURA · HOLE AND WELDING INCLUDED
LAVORAZIONE DI SALDATURA E PULITURA SU PIANO LUCIDO A SPECCHIO + € 120,00
WELDING AND CLEANING ON MIRROR-FINISHED TOPS + € 120,00

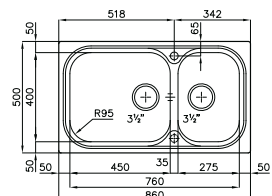

mod. 1562/001-2 DX/SX S. BIG BOWL



CODICE/code DIMENSIONI/size PREZZO/price

1120301 860x500 mm / vasca grande DX

1120401 860x500 mm / vasca grande SX

COMPRESO FORO E SALDATURA · HOLE AND WELDING INCLUDED
LAVORAZIONE DI SALDATURA E PULITURA SU PIANO LUCIDO A SPECCHIO + € 120,00
WELDING AND CLEANING ON MIRROR-FINISHED TOPS + € 120,00

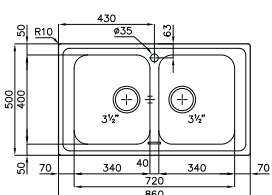

mod. 2182/060 KS



CODICE/code DIMENSIONI/size PREZZO/price

1122301 860x500 mm

COMPRESO FORO E SALDATURA · HOLE AND WELDING INCLUDED
LAVORAZIONE DI SALDATURA E PULITURA SU PIANO LUCIDO A SPECCHIO + € 120,00
WELDING AND CLEANING ON MIRROR-FINISHED TOPS + € 120,00

Lavelli Foster

Foster sinks

Lavelli 1 vasca + gocciolatoio 1-bowl sinks w/ drainer

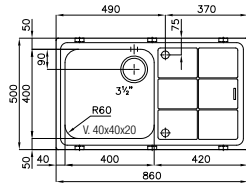

mod. 1381/061-2 DX/SX S. 3000



CODICE/code DIMENSIONI/size PREZZO/price

1120701 860x500 mm / vasca DX

1120801 860x500 mm / vasca SX

COMPRESO FORO E SALDATURA - HOLE AND WELDING INCLUDED
LAVORAZIONE DI SALDATURA E PULITURA SU PIANO LUCIDO A SPECCHIO + € 120,00
WELDING AND CLEANING ON MIRROR- FINISHED TOPS + € 120,00

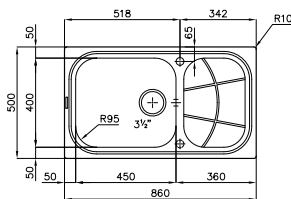

mod. 1561/201-2 DX/SX S. BIG BOWL



CODICE/code DIMENSIONI/size PREZZO/price

1120901 860x500 mm / vasca DX

1121001 860x500 mm / vasca SX

COMPRESO FORO E SALDATURA - HOLE AND WELDING INCLUDED
LAVORAZIONE DI SALDATURA E PULITURA SU PIANO LUCIDO A SPECCHIO + € 120,00
WELDING AND CLEANING ON MIRROR- FINISHED TOPS + € 120,00

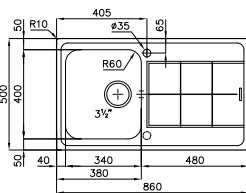

mod. 2181/061-2 DX/SX KS



CODICE/code DIMENSIONI/size PREZZO/price

1122401 860x500 mm / vasca DX

1122501 860x500 mm / vasca SX

COMPRESO FORO E SALDATURA - HOLE AND WELDING INCLUDED
LAVORAZIONE DI SALDATURA E PULITURA SU PIANO LUCIDO A SPECCHIO + € 120,00
WELDING AND CLEANING ON MIRROR- FINISHED TOPS + € 120,00

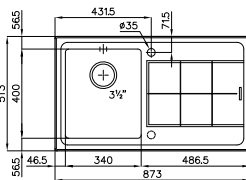

mod. 2281/051-2 DX/SX KE



CODICE/code DIMENSIONI/size PREZZO/price

1122601 873x513 mm / vasca DX

1122701 873x513 mm / vasca SX

COMPRESO FORO E SALDATURA - HOLE AND WELDING INCLUDED
LAVORAZIONE DI SALDATURA E PULITURA SU PIANO LUCIDO A SPECCHIO + € 120,00
WELDING AND CLEANING ON MIRROR- FINISHED TOPS + € 120,00

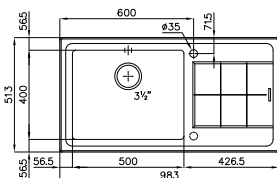

mod. 2263/051-2 DX/SX KE



CODICE/code DIMENSIONI/size PREZZO/price

1122801 983x513 mm / vasca DX

1122901 983x513 mm / vasca SX

COMPRESO FORO E SALDATURA - HOLE AND WELDING INCLUDED
LAVORAZIONE DI SALDATURA E PULITURA SU PIANO LUCIDO A SPECCHIO + € 120,00
WELDING AND CLEANING ON MIRROR- FINISHED TOPS + € 120,00

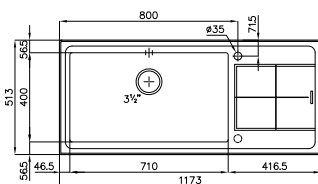

mod. 2211/051-2 DX/SX KE



CODICE/code DIMENSIONI/size PREZZO/price

1123001 1173x513 mm / vasca DX

1123101 1173x513 mm / vasca SX

COMPRESO FORO E SALDATURA - HOLE AND WELDING INCLUDED
LAVORAZIONE DI SALDATURA E PULITURA SU PIANO LUCIDO A SPECCHIO + € 120,00
WELDING AND CLEANING ON MIRROR- FINISHED TOPS + € 120,00

Lavelli Foster

Foster sinks

Lavelli 2 vasche + gocciolatoio 2-bowl sinks w/ drainer

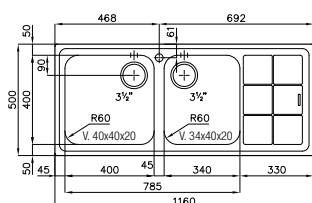

mod. 1312/061-2 DX/SX S. 3000



CODICE/code DIMENSIONI/size PREZZO/price

1121301 1160x500 mm / vasca DX

1121401 1160x500 mm / vasca SX

COMPRESO FORO E SALDATURA - HOLE AND WELDING INCLUDED
LAVORAZIONE DI SALDATURA E PULITURA SU PIANO LUCIDO A SPECCHIO + € 180,00
WELDING AND CLEANING ON MIRROR-FINISHED TOPS + € 180,00

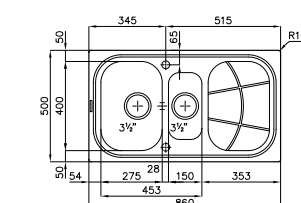

mod. 1361/261-2 DX/SX S. BIG BOWL



CODICE/code DIMENSIONI/size PREZZO/price

1123201 860x500 mm / vasca DX

1123301 860x500 mm / vasca SX

COMPRESO FORO E SALDATURA - HOLE AND WELDING INCLUDED
LAVORAZIONE DI SALDATURA E PULITURA SU PIANO LUCIDO A SPECCHIO + € 180,00
WELDING AND CLEANING ON MIRROR-FINISHED TOPS + € 180,00

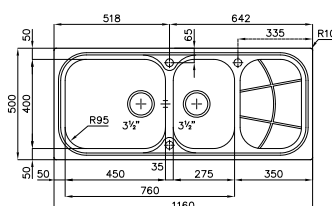

mod. 1512/201-2 DX/SX S. BIG BOWL



CODICE/code DIMENSIONI/size PREZZO/price

1121501 1160x500 mm / vasca DX

1121601 1160x500 mm / vasca SX

COMPRESO FORO E SALDATURA - HOLE AND WELDING INCLUDED
LAVORAZIONE DI SALDATURA E PULITURA SU PIANO LUCIDO A SPECCHIO + € 180,00
WELDING AND CLEANING ON MIRROR-FINISHED TOPS + € 180,00

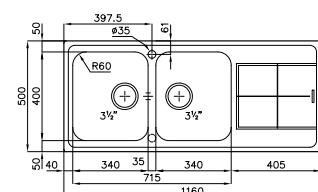

mod. 2112/061-2 DX/SX KS



CODICE/code DIMENSIONI/size PREZZO/price

1123401 1160x500 mm / vasca DX

1123501 1160x500 mm / vasca SX

COMPRESO FORO E SALDATURA - HOLE AND WELDING INCLUDED
LAVORAZIONE DI SALDATURA E PULITURA SU PIANO LUCIDO A SPECCHIO + € 180,00
WELDING AND CLEANING ON MIRROR-FINISHED TOPS + € 180,00

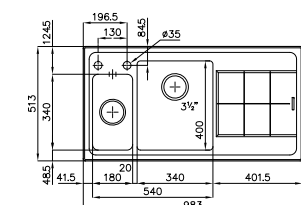

mod. 2297/051-2 DX/SX KE



CODICE/code DIMENSIONI/size PREZZO/price

1123601 983x513 mm / vasca grande DX

1123701 983x513 mm / vasca grande SX

COMPRESO FORO E SALDATURA - HOLE AND WELDING INCLUDED
LAVORAZIONE DI SALDATURA E PULITURA SU PIANO LUCIDO A SPECCHIO + € 120,00
WELDING AND CLEANING ON MIRROR-FINISHED TOPS + € 120,00

Lavelli Foster

Foster sinks

Lavelli 3 vasche 3-bowl sinks

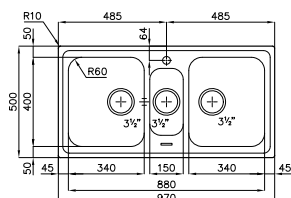

mod. 2173/060 KS



CODICE/code DIMENSIONI/size PREZZO/price

1123801 970x500 mm

COMPRESO FORO E SALDATURA · HOLE AND WELDING INCLUDED
LAVORAZIONE DI SALDATURA E PULITURA SU PIANO LUCIDO A SPECCHIO + € 120,00
WELDING AND CLEANING ON MIRROR- FINISHED TOPS + € 120,00

Lavelli speciali Special sinks

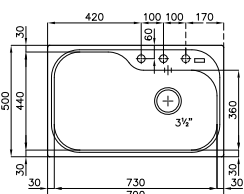

mod. 1679/660 TORNADO



CODICE/code DIMENSIONI/size PREZZO/price

1121701 790x500 mm

COMPRESO FORO E SALDATURA · HOLE AND WELDING INCLUDED
LAVORAZIONE DI SALDATURA E PULITURA SU PIANO LUCIDO A SPECCHIO + € 150,00
WELDING AND CLEANING ON MIRROR- FINISHED TOPS + € 150,00

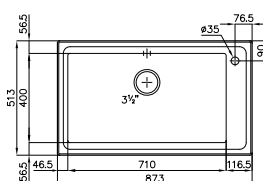

mod. 2287/050 KE



CODICE/code DIMENSIONI/size PREZZO/price

1123901 873x513 mm

COMPRESO FORO E SALDATURA · HOLE AND WELDING INCLUDED
LAVORAZIONE DI SALDATURA E PULITURA SU PIANO LUCIDO A SPECCHIO + € 120,00
WELDING AND CLEANING ON MIRROR- FINISHED TOPS + € 120,00

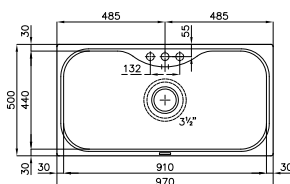

mod. 1555/600 URAGANO



CODICE/code DIMENSIONI/size PREZZO/price

1121801 970x500 mm

COMPRESO FORO E SALDATURA · HOLE AND WELDING INCLUDED
LAVORAZIONE DI SALDATURA E PULITURA SU PIANO LUCIDO A SPECCHIO + € 150,00
WELDING AND CLEANING ON MIRROR- FINISHED TOPS + € 150,00

Lavelli ad angolo c/gocciolatoio corner sinks w/ drainer

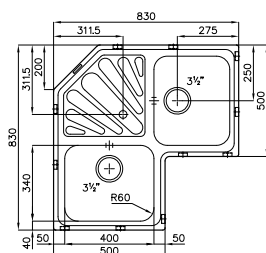

mod. 3307/060



CODICE/code DIMENSIONI/size PREZZO/price

1121901 830x830x500 mm

COMPRESO FORO E SALDATURA · HOLE AND WELDING INCLUDED
LAVORAZIONE DI SALDATURA E PULITURA SU PIANO LUCIDO A SPECCHIO + € 250,00
WELDING AND CLEANING ON MIRROR- FINISHED TOPS + € 250,00

Lavelli FRANKE

Franke sinks



Realizzate in acciaio INOX AISI 304, 18-10 con pilettonone 3" 1/2 in acciaio INOX AISI 304, 18-10 con troppo pieno.

Made of AISI 304, 18-10 stainless steel with 3" 1/2 AISI 304, 18-10 stainless steel sink drain and overflow.

Compreso foro e saldatura / Hole and welding included

Lavelli 2 vasche 2-bowl sinks

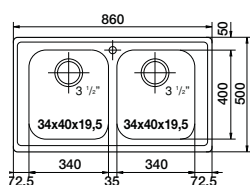

mod. FOX 620 S. FUTURO



CODICE/code DIMENSIONI/size PREZZO/price

113010100 860x500 mm

COMPRESO FORO E SALDATURA · HOLE AND WELDING INCLUDED
LAVORAZIONE DI SALDATURA E PULITURA SU PIANO LUCIDO A SPECCHIO + € 120,00
WELDING AND CLEANING ON MIRROR-FINISHED TOPS + € 120,00

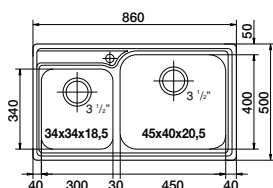

mod. GAX 620 S. GALASSIA



CODICE/code DIMENSIONI/size PREZZO/price

113020100 860x500 mm

COMPRESO FORO E SALDATURA · HOLE AND WELDING INCLUDED
LAVORAZIONE DI SALDATURA E PULITURA SU PIANO LUCIDO A SPECCHIO + € 120,00
WELDING AND CLEANING ON MIRROR-FINISHED TOPS + € 120,00

Lavelli 1 vasca + gocciolatoio 1-bowl sinks w/ drainer

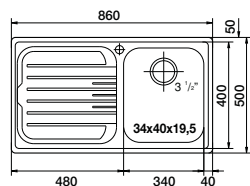

mod. FOX 611/2-7 S. FUTURO DX/SX



CODICE/code DIMENSIONI/size PREZZO/price

113050100 860x500 mm / gocc. DX

113040100 860x500 mm / gocc. SX

COMPRESO FORO E SALDATURA · HOLE AND WELDING INCLUDED
LAVORAZIONE DI SALDATURA E PULITURA SU PIANO LUCIDO A SPECCHIO + € 120,00
WELDING AND CLEANING ON MIRROR-FINISHED TOPS + € 120,00

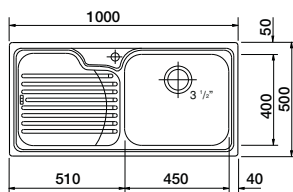

mod. GAX 611 GALASSIA DX/SX



CODICE/code DIMENSIONI/size PREZZO/price

113200102 1000x500 mm / gocc. DX

113200107 1000x500 mm / gocc. SX

COMPRESO FORO E SALDATURA · HOLE AND WELDING INCLUDED
LAVORAZIONE DI SALDATURA E PULITURA SU PIANO LUCIDO A SPECCHIO + € 120,00
WELDING AND CLEANING ON MIRROR-FINISHED TOPS + € 120,00

Lavelli Franke

Franke sinks

Lavelli 2 vasca + gocciolatoio 2-bowl sinks w/ drainer

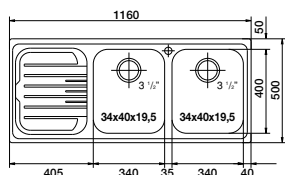

mod. FOX 621/2-7 S. FUTURO DX/SX



CODICE/code DIMENSIONI/size PREZZO/price

113080100 1160x500 mm / gocc. DX

113090100 1160x500 mm / gocc. SX

COMPRESO FORO E SALDATURA · HOLE AND WELDING INCLUDED
LAVORAZIONE DI SALDATURA E PULITURA SU PIANO LUCIDO A SPECCHIO + € 180,00
WELDING AND CLEANING ON MIRROR-FINISHED TOPS + € 180,00

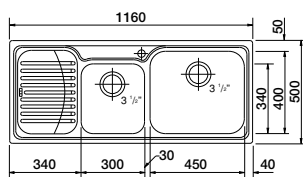

mod. GAX 621/2-7 S. GALASSIA DX/SX



CODICE/code DIMENSIONI/size PREZZO/price

113100100 1160x500 mm / gocc. DX

113110100 1160x500 mm / gocc. SX

COMPRESO FORO E SALDATURA · HOLE AND WELDING INCLUDED
LAVORAZIONE DI SALDATURA E PULITURA SU PIANO LUCIDO A SPECCHIO + € 180,00
WELDING AND CLEANING ON MIRROR-FINISHED TOPS + € 180,00

Lavelli speciali special sinks

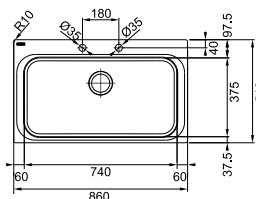

mod. AEX 610 ACQUARIO LINE



CODICE/code DIMENSIONI/size PREZZO/price

113140101 860x500 mm

COMPRESO FORO E SALDATURA · HOLE AND WELDING INCLUDED
LAVORAZIONE DI SALDATURA E PULITURA SU PIANO LUCIDO A SPECCHIO + € 150,00
WELDING AND CLEANING ON MIRROR-FINISHED TOPS + € 150,00

Lavelli ad angolo c/gocciolatoio corner sinks w/ drainer

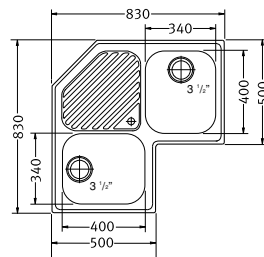

mod. PNX 621/E



CODICE/code DIMENSIONI/size PREZZO/price

113150100 830x830x500 mm

COMPRESO FORO E SALDATURA · HOLE AND WELDING INCLUDED
LAVORAZIONE DI SALDATURA E PULITURA SU PIANO LUCIDO A SPECCHIO + € 250,00
WELDING AND CLEANING ON MIRROR-FINISHED TOPS + € 250,00