

VI-HOME KITCHEN

La cucina PROFESSIONALE THE PROFESSIONAL KITCHEN



VI-HOME KITCHEN è la nuova gamma di cucine interamente realizzate in acciaio inox che Vittinox ha creato per chi vuole una cucina professionale in casa propria. Flessibilità, ecologia e durevolezza unita ad un design moderno dalle linee nitide.

VI-HOME KITCHEN is the new kitchen range totally made in stainless steel, perfect for people looking for a professional kitchen at home. Flexibility, ecology and long-life durability together with a clean and modern design.

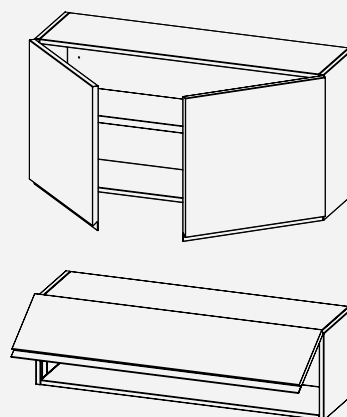
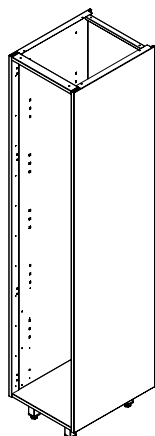
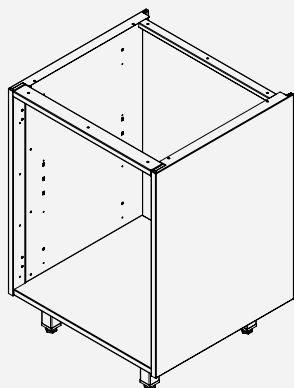

Basi

Sistema di basi in acciaio inox Aisi 304 Scotch Brite altezza 72 cm e profondità 56 cm, nelle lunghezze 30-45-60-90-120 cm, ad angolo e sottolavello, attrezzabili con ante, cassetti, cestoni e ripiani. Dotate di piedini regolabili con altezza variabile da 100 a 150 mm già provvisti di magneti per l'applicazione dello zoccolo.

Cabinets

Stainless steel cabinets system 72 cm high, 56 cm deep and 30-45-60-90-120 cm long, corner and under sink models, with doors, drawers and shelves. Supplied with adjustable feet with range from 100 to 150 mm and equipped with magnets for baseboard fixing.

Colonne

Sistema di colonne in acciaio inox Aisi 304 Scotch Brite altezza 204 cm e profondità 56 cm nelle lunghezze 45 e 60 cm, attrezzabili con ante, cassetti, cestoni e ripiani fissi o mobili per creare vani forno, macchina da caffè, abbattitore ecc. Dotate di piedini regolabili con altezza variabile da 100 a 150 mm già provvisti di magneti per l'applicazione dello zoccolo.

Columns

Stainless steel columns system 204 cm high, 56 cm deep and 45-60 cm long, with doors, drawers and shelves. Supplied with adjustable feet with range from 100 to 150 mm and equipped with magnets for baseboard fixing.

Pensili

Sistema di pensili in acciaio inox Aisi 304 Scotch Brite nelle misure 45-60-90-120 cm. Disponibili nelle altezze 36-60 cm con ante basculanti e 60-72 cm con ante a battente. La versione da 120 h60 è disponibile solo con ante a battente.

Wall cabinets

Stainless steel wall cabinets system 45-60-90-120 cm long, 36-60 cm high with folding doors, and 60-72 cm high with shutter doors. The wall cabinet 120 cm length and 60 cm height model is available only with shutter doors.



AISI 304 STAINLESS STEEL

VI-HOME KITCHEN è totalmente realizzata in acciaio inox AISI 304 18/10 in finitura Scotch Brite, per garantire la massima igiene in cucina e per una lunga durata nel tempo.

VI-HOME KITCHEN is totally made in AISI 304 18/10 stainless steel with Scotch Brite finish for maximum hygiene and long- life durable.



Anta Standard

Anta in acciaio inox Aisi 304 Scotch Brite nello spessore 20 mm, realizzata con pannello e contro pannello e rinforzo interno. È possibile l'applicazione di maniglie esterne che, se preventivamente fornite, saranno applicate prima della consegna.

Standard door

Stainless steel Aisi 304 scotch brite finish door, 20 mm thick, with hood panel indoor. It is possible to apply customer provided handles before supply.

Anta GOLA

Anta in acciaio inox Aisi 304 Scotch Brite nello spessore 25 mm, realizzata con pannello e contro pannello e rinforzo interno. La particolare conformazione dell'anta crea una gola che funge da maniglia donando all'insieme un design pulito ed essenziale.

MOLDING door

Stainless steel Aisi 304 scotch brite finish door, 25 mm thick, with hood panel indoor. The specific shape of the door form a dip that works as a handle adding to the clean and essential overall design.

Accessori

Sempre attenta alle esigenze del cliente, Vittinox offre una serie di accessori a completamento della gamma, interamente personalizzabili, quali porta mestoli, vassoi, cola piatti e bicchieri, colapasta, taglieri ecc.

Accessories

Always careful to customer needs, Vittinox offers a variety of fully customizable accessories to complete the range of products, like trays, plates and glasses rack, colander, cutting boards etc.



Basi 300 mm

Cabinets 300 mm

Base standard H 720 mm

Standard cabinet H 720 mm
H 120/150 mm piedini / feet

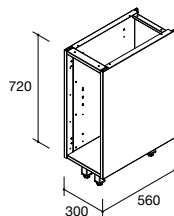

| CODICE/code | DIMENSIONI/size |
|-------------|-----------------|
| 4100101030 | 300x560x720 mm |

Ripiano per base con supporti

Shelf for cabinet
with supports

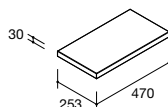

| CODICE/code | DIMENSIONI/size |
|-------------|-----------------|
| 4101101030 | 253x470x30 mm |

Anta Standard

Standard door

Anta montata con
cerniere Blumotion 110°
Mounted door with
Blumotion 110° hinge

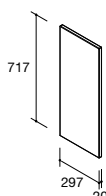

| CODICE/code | DIMENSIONI/size |
|-------------|-----------------|
| 4101201030 | 297x717x20 mm |

Anta Gola

Molding door

Anta montata con
cerniere Blumotion 110°
Mounted door with
Blumotion 110° hinge

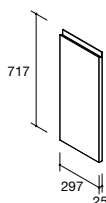

| CODICE/code | DIMENSIONI/size |
|-------------|------------------|
| 4101301031 | 297x717x25 mm DX |
| 4101301032 | 297x717x25 mm SX |

Cassetto Standard H 117 mm

Standard drawer H 117 mm

Cassetto montato inox
con guide "Blum" e frontale
Mounted drawer with blum rails
and front panel

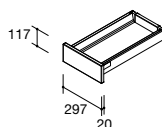

| CODICE/code | DIMENSIONI/size |
|-------------|-----------------|
| 4102101030 | 297x117x20 mm |

Cassetto Standard H 177 mm

Standard drawer H 177 mm

Cassetto montato inox
con guide "Blum" e frontale
Mounted drawer with blum rails
and front panel

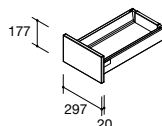

| CODICE/code | DIMENSIONI/size |
|-------------|-----------------|
| 4102201030 | 297x177x20 mm |

Cassetto Gola H 177 mm

Molding drawer H 177 mm

Cassetto montato inox
con guide "Blum" e frontale
Mounted drawer with blum rails
and front panel

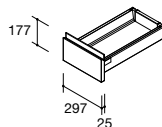

| CODICE/code | DIMENSIONI/size |
|-------------|-----------------|
| 4103101030 | 297x177x25 mm |

Cassetto interno

Inner drawer

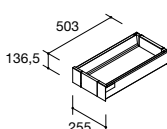

| CODICE/code | DIMENSIONI/size |
|-------------|------------------|
| 4102601030 | 255x503x136,5 mm |

Basi 300 mm

Cabinets 300 mm

Cestone Standard H 717 mm

Standard high fronted
pull-out H 717 mm

Cestone montato inox
con guide "Blum" e frontale
Mounted high fronted pull-out
with blum rails and front panel

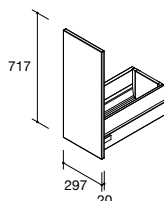

| CODICE/code | DIMENSIONI/size |
|-------------|-----------------|
| 4102501030 | 297x717x20 mm |

Cestone Gola H 717 mm

Molding high fronted
pull-out H 717 mm

Cestone montato inox
con guide "Blum" e frontale
Mounted high fronted pull-out
with blum rails and front panel

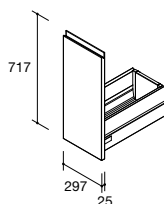

| CODICE/code | DIMENSIONI/size |
|-------------|-----------------|
| 4103401030 | 297x717x25 mm |

Cestone Standard H 537 mm

Standard high fronted
pull-out H 537 mm

Cestone montato inox
con guide "Blum" e frontale
Mounted high fronted pull-out
with blum rails and front panel

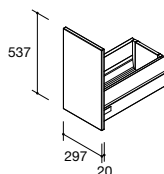

| CODICE/code | DIMENSIONI/size |
|-------------|-----------------|
| 4102401030 | 297x537x20 mm |

Cestone Gola H 537 mm

Molding high fronted
pull-out H 537 mm

Cestone montato inox
con guide "Blum" e frontale
Mounted high fronted pull-out
with blum rails and front panel

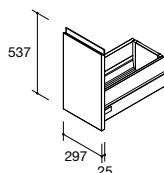

| CODICE/code | DIMENSIONI/size |
|-------------|-----------------|
| 4103301030 | 297x537x25 mm |

Cestone Standard H 357 mm

Standard high fronted
pull-out H 357 mm

Cestone montato inox
con guide "Blum" e frontale
Mounted high fronted pull-out
with blum rails and front panel

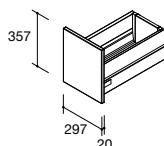

| CODICE/code | DIMENSIONI/size |
|-------------|-----------------|
| 4102301030 | 297x357x20 mm |

Cestone Gola H 357 mm

Molding high fronted
pull-out H 357 mm

Cestone montato inox
con guide "Blum" e frontale
Mounted high fronted pull-out
with blum rails and front panel

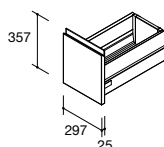

| CODICE/code | DIMENSIONI/size |
|-------------|-----------------|
| 4103201030 | 297x357x25 mm |

Cestone Interno

Inner high fronted pull-out

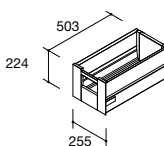

| CODICE/code | DIMENSIONI/size |
|-------------|-----------------|
| 4102701030 | 255x503x224 mm |

Basi 450 mm

Cabinets 450 mm

Base standard H 720 mm

Standard cabinet H 720 mm
H 120/150 mm piedini / feet

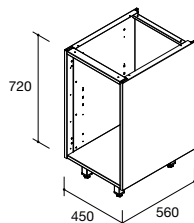

| CODICE/code | DIMENSIONI/size |
|-------------|-----------------|
| 4100101045 | 450x560x720 mm |

Ripiano per base con supporti

Shelf for cabinet
with supports

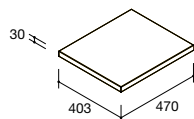

| CODICE/code | DIMENSIONI/size |
|-------------|-----------------|
| 4101101045 | 403x470x30 mm |

Anta Standard

Standard door

Anta montata con cerniere
Blumotion 110°
Mounted door with
Blumotion 110° hinge

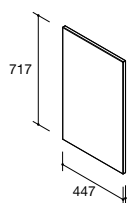

| CODICE/code | DIMENSIONI/size |
|-------------|-----------------|
| 4101201045 | 447x717x20 mm |

Anta Gola

Molding door

Anta montata con cerniere
Blumotion 110°
Mounted door with
Blumotion 110° hinge

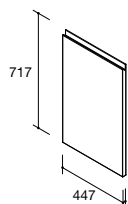

| CODICE/code | DIMENSIONI/size |
|-------------|------------------|
| 4101301046 | 447x717x25 mm DX |
| 4101301047 | 447x717x25 mm SX |

Cassetto Standard H 117 mm

Standard drawer H 117 mm

Cassetto montato inox
con guide "Blum" e frontale
Mounted drawer with blum rails
and front panel

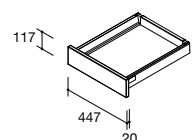

| CODICE/code | DIMENSIONI/size |
|-------------|-----------------|
| 4102101045 | 447x117x20 mm |

Cassetto Standard H 177 mm

Standard drawer H 177 mm

Cassetto montato inox
con guide "Blum" e frontale
Mounted drawer with blum rails
and front panel

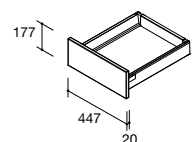

| CODICE/code | DIMENSIONI/size |
|-------------|-----------------|
| 4102201045 | 447x177x20 mm |

Cassetto Gola H 177 mm

Molding drawer H 177 mm

Cassetto montato inox
con guide "Blum" e frontale
Mounted drawer with blum rails
and front panel

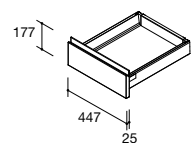

| CODICE/code | DIMENSIONI/size |
|-------------|-----------------|
| 4103101045 | 447x177x25 mm |

Cassetto interno

Inner drawer

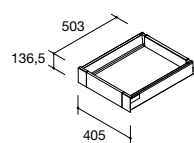

| CODICE/code | DIMENSIONI/size |
|-------------|------------------|
| 4102601045 | 405x503x136,5 mm |

Basi 450 mm

Cabinets 450 mm

Cestone Standard H 717 mm

Standard high fronted
pull-out H 717 mm

Cestone montato inox
con guide "Blum" e frontale
Mounted high fronted pull-out
with blum rails and front panel

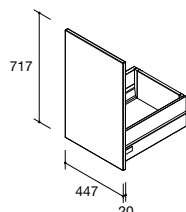

| CODICE/code | DIMENSIONI/size |
|-------------|-----------------|
| 4102501045 | 447x717x20 mm |

Cestone Gola H 717 mm

Molding high fronted
pull-out H 717 mm

Cestone montato inox
con guide "Blum" e frontale
Mounted high fronted pull-out
with blum rails and front panel

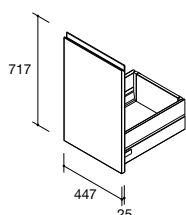

| CODICE/code | DIMENSIONI/size |
|-------------|-----------------|
| 4103401045 | 447x717x25 mm |

Cestone Standard H 537 mm

Standard high fronted
pull-out H 537 mm

Cestone montato inox
con guide "Blum" e frontale
Mounted high fronted pull-out
with blum rails and front panel

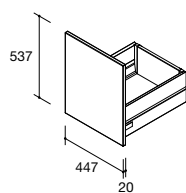

| CODICE/code | DIMENSIONI/size |
|-------------|-----------------|
| 4102401045 | 447x537x20 mm |

Cestone Gola H 537 mm

Molding high fronted
pull-out H 537 mm

Cestone montato inox
con guide "Blum" e frontale
Mounted high fronted pull-out
with blum rails and front panel

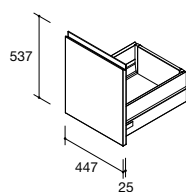

| CODICE/code | DIMENSIONI/size |
|-------------|-----------------|
| 4103301045 | 447x537x25 mm |

Cestone Standard H 357 mm

Standard high fronted
pull-out H 357 mm

Cestone montato inox
con guide "Blum" e frontale
Mounted high fronted pull-out
with blum rails and front panel

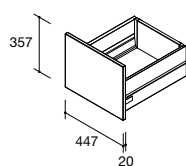

| CODICE/code | DIMENSIONI/size |
|-------------|-----------------|
| 4102301045 | 447x357x20 mm |

Cestone Gola H 357 mm

Molding high fronted
pull-out H 357 mm

Cestone montato inox
con guide "Blum" e frontale
Mounted high fronted pull-out
with blum rails and front panel

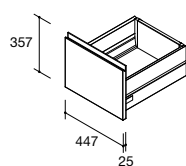

| CODICE/code | DIMENSIONI/size |
|-------------|-----------------|
| 4103201045 | 447x357x25 mm |

Cestone Interno

Inner high fronted pull-out

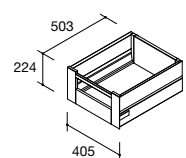

| CODICE/code | DIMENSIONI/size |
|-------------|-----------------|
| 4102701045 | 405x503x224 mm |

Basi 600 mm

Cabinets 600 mm

Base standard H 720 mm

Standard cabinet H 720 mm
H 120/150 mm piedini / feet

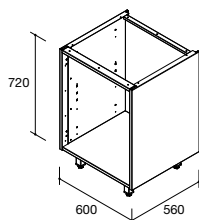

| CODICE/code | DIMENSIONI/size |
|-------------|-----------------|
| 4100101060 | 600x560x720 mm |

Base forno H 720 mm

Oven cabinet H 720 mm
H 120/150 mm piedini / feet

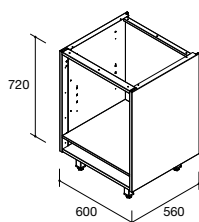

| CODICE/code | DIMENSIONI/size |
|-------------|-----------------|
| 4100101061 | 600x560x720 mm |

Ripiano per base con supporti

Shelf for cabinet
with supports

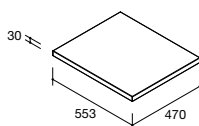

| CODICE/code | DIMENSIONI/size |
|-------------|-----------------|
| 4101101060 | 553x470x30 mm |

Anta Standard

Standard door

Anta montata con cerniere Blumotion 110°
Mounted door with Blumotion 110° hinge

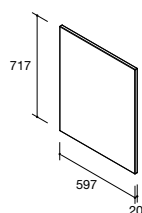

| CODICE/code | DIMENSIONI/size |
|-------------|-----------------|
| 4101201060 | 597x717x20 mm |

Anta Gola

Molding door

Anta montata con cerniere Blumotion 110°
Mounted door with Blumotion 110° hinge

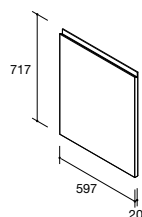

| CODICE/code | DIMENSIONI/size |
|-------------|------------------|
| 4101301061 | 597x717x25 mm DX |
| 4101301062 | 597x717x25 mm SX |

Cassetto Standard H 117 mm

Standard drawer H 117 mm

Cassetto montato inox con guide "Blum" e frontale
Mounted drawer with blum rails and front panel

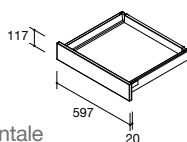

| CODICE/code | DIMENSIONI/size |
|-------------|-----------------|
| 4102101060 | 597x117x20 mm |

Cassetto Standard H 177 mm

Standard drawer H 177 mm

Cassetto montato inox con guide "Blum" e frontale
Mounted drawer with blum rails and front panel

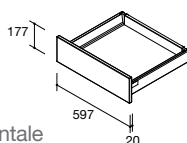

| CODICE/code | DIMENSIONI/size |
|-------------|-----------------|
| 4102201060 | 597x177x20 mm |

Cassetto Gola H 177 mm

Molding drawer H 177 mm

Cassetto montato inox con guide "Blum" e frontale
Mounted drawer with blum rails and front panel

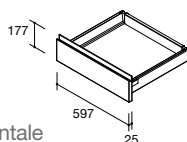

| CODICE/code | DIMENSIONI/size |
|-------------|-----------------|
| 4103101060 | 597x177x25 mm |

Basi 600 mm

Cabinets 600 mm

Cassetto interno

Inner drawer

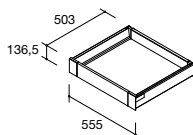

| CODICE/code | DIMENSIONI/size |
|-------------|------------------|
| 4102601060 | 555x503x136,5 mm |

Cestone Standard H 717 mm

Standard high fronted pull-out H 717 mm

Cestone montato inox con guide "Blum" e frontale
Mounted high fronted pull-out with blum rails and front panel

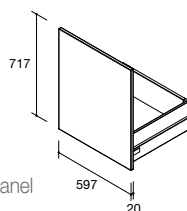

| CODICE/code | DIMENSIONI/size |
|-------------|-----------------|
| 4102501060 | 597x717x20 mm |

Cestone Gola H 717 mm

Molding high fronted pull-out H 717 mm

Cestone montato inox con guide "Blum" e frontale
Mounted high fronted pull-out with blum rails and front panel

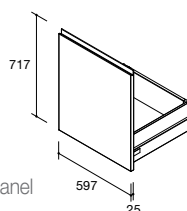

| CODICE/code | DIMENSIONI/size |
|-------------|-----------------|
| 4103401060 | 597x717x25 mm |

Cestone Standard H 537 mm

Standard high fronted pull-out H 537 mm

Cestone montato inox con guide "Blum" e frontale
Mounted high fronted pull-out with blum rails and front panel

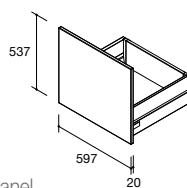

| CODICE/code | DIMENSIONI/size |
|-------------|-----------------|
| 4102401060 | 597x537x20 mm |

Cestone Gola H 537 mm

Molding high fronted pull-out H 537 mm

Cestone montato inox con guide "Blum" e frontale
Mounted high fronted pull-out with blum rails and front panel

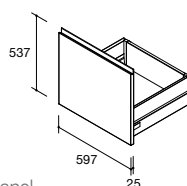

| CODICE/code | DIMENSIONI/size |
|-------------|-----------------|
| 4103301060 | 597x537x25 mm |

Cestone Standard H 357 mm

Standard high fronted pull-out H 357 mm

Cestone montato inox con guide "Blum" e frontale
Mounted high fronted pull-out with blum rails and front panel

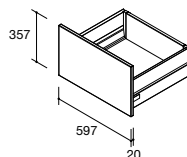

| CODICE/code | DIMENSIONI/size |
|-------------|-----------------|
| 4102301060 | 597x357x20 mm |

Cestone Gola H 357 mm

Molding high fronted pull-out H 357 mm

Cestone montato inox con guide "Blum" e frontale
Mounted high fronted pull-out with blum rails and front panel

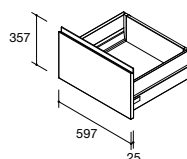

| CODICE/code | DIMENSIONI/size |
|-------------|-----------------|
| 4103201060 | 597x357x25 mm |

Cestone Interno

Inner high fronted pull-out

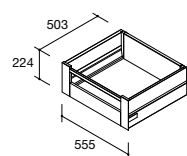

| CODICE/code | DIMENSIONI/size |
|-------------|-----------------|
| 4102701060 | 555x503x224 mm |

Basi 900 mm

Cabinets 900 mm

Base standard H 720 mm

Standard cabinet H 720 mm
H 120/150 mm piedini / feet

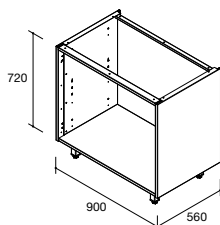

| CODICE/code | DIMENSIONI/size |
|-------------|-----------------|
| 4100101090 | 900x560x720 mm |

Base lavaggio H 720 mm

Under sink cabinet H 720 mm
H 120/150 mm piedini / feet

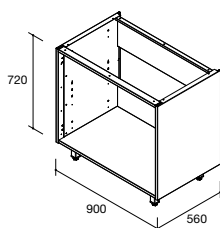

| CODICE/code | DIMENSIONI/size |
|-------------|-----------------|
| 4100101091 | 900x560x720 mm |

Ripiano per base con supporti

Shelf for cabinet
with supports

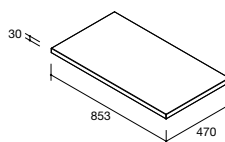

| CODICE/code | DIMENSIONI/size |
|-------------|-----------------|
| 4101101090 | 853x470x30 mm |

2 ante Standard

2 standard doors

Anta montata con cerniere Blumotion 110°
Mounted door with Blumotion 110° hinge

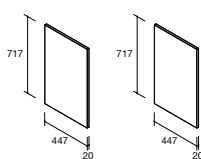

| CODICE/code | DIMENSIONI/size |
|-------------|-----------------|
| 4101201045 | 447x717x20 mm |

2 ante Gola

2 molding doors

Anta montata con cerniere Blumotion 110°
Mounted door with Blumotion 110° hinge

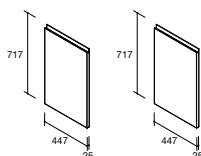

| CODICE/code | DIMENSIONI/size |
|-------------|------------------|
| 4101301046 | 447x717x25 mm DX |
| 4101301047 | 447x717x25 mm SX |

Cassetto Standard H 117 mm

Standard drawer H 117 mm

Cassetto montato inox con guide "Blum" e frontale
Mounted drawer with blum rails and front panel

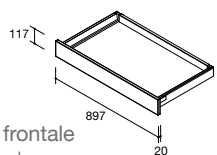

| CODICE/code | DIMENSIONI/size |
|-------------|-----------------|
| 4102101090 | 897x117x20 mm |

Cassetto Standard H 177 mm

Standard drawer H 177 mm

Cassetto montato inox con guide "Blum" e frontale
Mounted drawer with blum rails and front panel

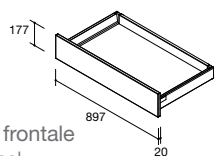

| CODICE/code | DIMENSIONI/size |
|-------------|-----------------|
| 4102201090 | 897x177x20 mm |

Cassetto Gola H 177 mm

Molding drawer H 177 mm

Cassetto montato inox con guide "Blum" e frontale
Mounted drawer with blum rails and front panel

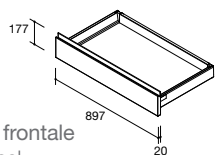

| CODICE/code | DIMENSIONI/size |
|-------------|-----------------|
| 4103101090 | 897x177x25 mm |

Basi 900 mm

Cabinets 900 mm

Cassetto interno

Inner drawer

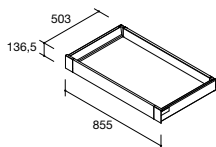

| CODICE/code | DIMENSIONI/size |
|-------------|------------------|
| 4102601090 | 855x503x136,5 mm |

Cestone Standard H 717 mm

Standard high fronted pull-out H 717 mm

Cestone montato inox con guide "Blum" e frontale
Mounted high fronted pull-out with blum rails and front panel

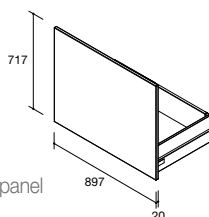

| CODICE/code | DIMENSIONI/size |
|-------------|-----------------|
| 4102501090 | 897x717x20 mm |

Cestone Gola H 717 mm

Molding high fronted pull-out H 717 mm

Cestone montato inox con guide "Blum" e frontale
Mounted high fronted pull-out with blum rails and front panel

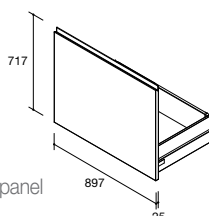

| CODICE/code | DIMENSIONI/size |
|-------------|-----------------|
| 4103401090 | 897x717x25 mm |

Cestone Standard H 537 mm

Standard high fronted pull-out H 537 mm

Cestone montato inox con guide "Blum" e frontale
Mounted high fronted pull-out with blum rails and front panel

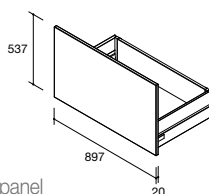

| CODICE/code | DIMENSIONI/size |
|-------------|-----------------|
| 4102401090 | 897x537x20 mm |

Cestone Gola H 537 mm

Molding high fronted pull-out H 537 mm

Cestone montato inox con guide "Blum" e frontale
Mounted high fronted pull-out with blum rails and front panel

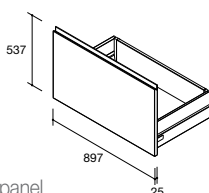

| CODICE/code | DIMENSIONI/size |
|-------------|-----------------|
| 4103301090 | 897x537x25 mm |

Cestone Standard H 357 mm

Standard high fronted pull-out H 357 mm

Cestone montato inox con guide "Blum" e frontale
Mounted high fronted pull-out with blum rails and front panel

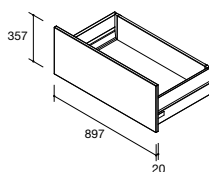

| CODICE/code | DIMENSIONI/size |
|-------------|-----------------|
| 4102301090 | 897x357x20 mm |

Cestone Gola H 357 mm

Molding high fronted pull-out H 357 mm

Cestone montato inox con guide "Blum" e frontale
Mounted high fronted pull-out with blum rails and front panel

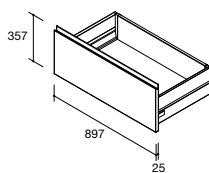

| CODICE/code | DIMENSIONI/size |
|-------------|-----------------|
| 4103201090 | 897x357x25 mm |

Cestone Interno

Inner high fronted pull-out

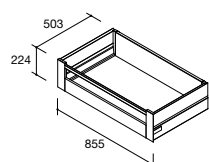

| CODICE/code | DIMENSIONI/size |
|-------------|-----------------|
| 4102701090 | 855x503x224 mm |

Basi 1200 mm

Cabinets 1200 mm

Base standard H 720 mm

Standard cabinet H 720 mm
H 120/150 mm piedini / feet

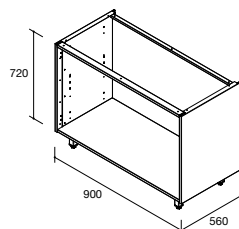

| CODICE/code | DIMENSIONI/size |
|-------------|-----------------|
| 4100101120 | 1200x560x720 mm |

Base lavaggio H 720 mm

Under sink cabinet H 720 mm
H 120/150 mm piedini / feet

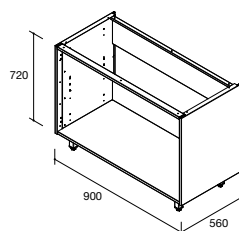

| CODICE/code | DIMENSIONI/size |
|-------------|-----------------|
| 4100101121 | 1200x560x720 mm |

Ripiano per base con supporti

Shelf for cabinet
with supports

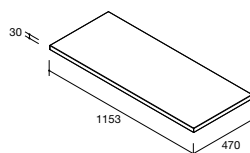

| CODICE/code | DIMENSIONI/size |
|-------------|-----------------|
| 4101101120 | 1153x470x30 mm |

2 ante Standard

2 standard doors

Anta montata con cerniere Blumotion 110°
Mounted door with Blumotion 110° hinge

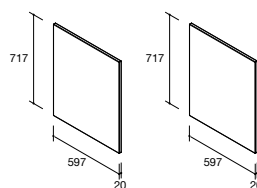

| CODICE/code | DIMENSIONI/size |
|-------------|-----------------|
| 4101201060 | 597x717x20 mm |

2 ante Gola

2 molding doors

Anta montata con cerniere Blumotion 110°
Mounted door with Blumotion 110° hinge

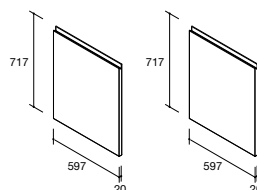

| CODICE/code | DIMENSIONI/size |
|-------------|------------------|
| 4101301061 | 597x717x25 mm DX |
| 4101301062 | 597x717x25 mm SX |

Cassetto Standard H 117 mm

Standard drawer H 117 mm

Cassetto montato inox con guide "Blum" e frontale
Mounted drawer with blum rails and front panel

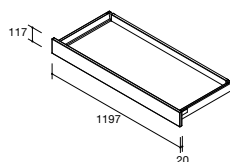

| CODICE/code | DIMENSIONI/size |
|-------------|-----------------|
| 4102101120 | 1197x117x20 mm |

Cassetto Standard H 177 mm

Standard drawer H 177 mm

Cassetto montato inox con guide "Blum" e frontale
Mounted drawer with blum rails and front panel

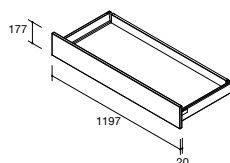

| CODICE/code | DIMENSIONI/size |
|-------------|-----------------|
| 4102201120 | 1197x177x20 mm |

Cassetto Gola H 177 mm

Molding drawer H 177 mm

Cassetto montato inox con guide "Blum" e frontale
Mounted drawer with blum rails and front panel

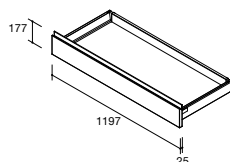

| CODICE/code | DIMENSIONI/size |
|-------------|-----------------|
| 4103101120 | 1197x177x25 mm |

Basi 1200 mm

Cabinets 1200 mm

Cassetto interno

Inner drawer

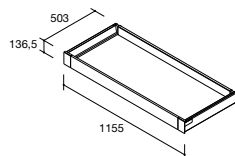

| CODICE/code | DIMENSIONI/size |
|-------------|-------------------|
| 4102601120 | 1155x503x136,5 mm |

Cestone Standard H 717 mm

Standard high fronted pull-out H 717 mm

Cestone montato inox con guide "Blum" e frontale
Mounted high fronted pull-out with blum rails and front panel

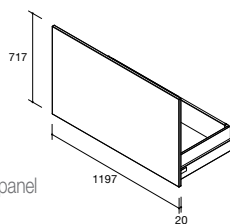

| CODICE/code | DIMENSIONI/size |
|-------------|-----------------|
| 4102501120 | 1197x717x20 mm |

Cestone Gola H 717 mm

Molding high fronted pull-out H 717 mm

Cestone montato inox con guide "Blum" e frontale
Mounted high fronted pull-out with blum rails and front panel

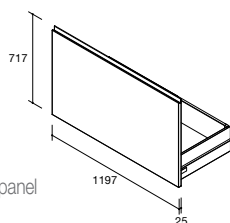

| CODICE/code | DIMENSIONI/size |
|-------------|-----------------|
| 4103401120 | 1197x717x25 mm |

Cestone Standard H 537 mm

Standard high fronted pull-out H 537 mm

Cestone montato inox con guide "Blum" e frontale
Mounted high fronted pull-out with blum rails and front panel

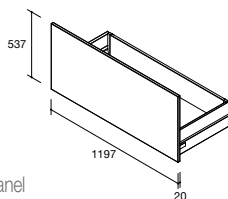

| CODICE/code | DIMENSIONI/size |
|-------------|-----------------|
| 4102401120 | 1197x537x20 mm |

Cestone Gola H 537 mm

Molding high fronted pull-out H 537 mm

Cestone montato inox con guide "Blum" e frontale
Molding high fronted pull-out with blum rails and front panel

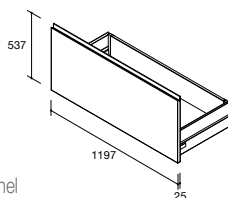

| CODICE/code | DIMENSIONI/size |
|-------------|-----------------|
| 4103301120 | 1197x537x25 mm |

Cestone Standard H 357 mm

Standard high fronted pull-out H 357 mm

Cestone montato inox con guide "Blum" e frontale
Mounted high fronted pull-out with blum rails and front panel

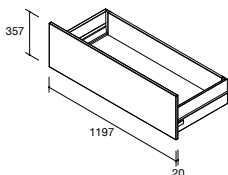

| CODICE/code | DIMENSIONI/size |
|-------------|-----------------|
| 4102301120 | 1197x357x20 mm |

Cestone Gola H 357 mm

Molding high fronted pull-out H 357 mm

Cestone montato inox con guide "Blum" e frontale
Mounted high fronted pull-out with blum rails and front panel

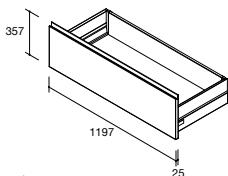

| CODICE/code | DIMENSIONI/size |
|-------------|-----------------|
| 4103201120 | 1197x357x25 mm |

Cestone Interno

Inner high fronted pull-out

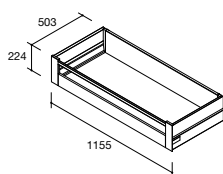

| CODICE/code | DIMENSIONI/size |
|-------------|-----------------|
| 4102701120 | 1155x503x224 mm |

Basi angolo

Corner cabinets

Base angolo

H 720 mm

Corner cabinet
H 720 mm

H 120/150 mm
piedini / feet

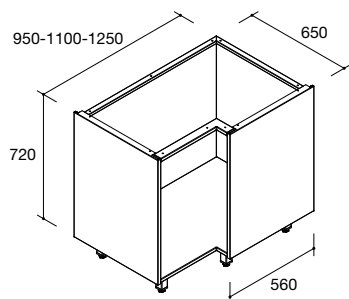
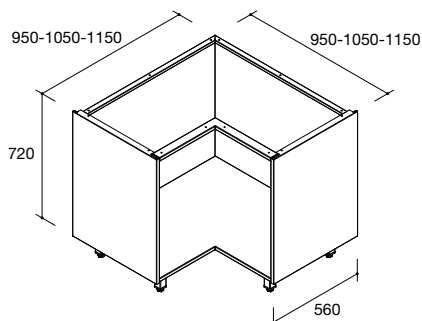

| CODICE/code | DIMENSIONI/size |
|-------------|---------------------|
| 4100201010 | 950x950xH720 mm |
| 4100201020 | 1050x1050xH720 mm |
| 4100201030 | 1150x1150xH720 mm |
| 4100201041 | 950x650xH720 mm DX |
| 4100201042 | 950x650xH720 mm SX |
| 4100201051 | 1100x650xH720 mm DX |
| 4100201052 | 1100x650xH720 mm SX |
| 4100201061 | 1250x650xH720 mm DX |
| 4100201062 | 1250x650xH720 mm SX |

Anta Standard

Standard door

Anta montata con cerniere
Blumotion 155°
Mounted door with
Blumotion 155° hinge

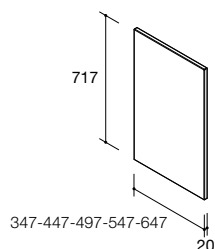

| CODICE/code | DIMENSIONI/size |
|-------------|-----------------|
| 4101401035 | 347x717x20 mm |
| 4101401045 | 447x717x20 mm |
| 4101401050 | 497x717x20 mm |
| 4101401055 | 547x717x20 mm |
| 4101401065 | 647x717x20 mm |

Anta Gola

Molding door

Anta montata con cerniere
Blumotion 155°
Mounted door with
Blumotion 155° hinge

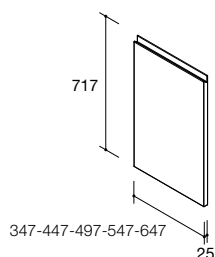

| CODICE/code | DIMENSIONI/size |
|-------------|------------------|
| 4101501036 | 347x717x25 mm DX |
| 4101501037 | 347x717x25 mm SX |
| 4101501046 | 447x717x25 mm DX |
| 4101501047 | 447x717x25 mm SX |
| 4101501051 | 497x717x25 mm DX |
| 4101501052 | 497x717x25 mm SX |
| 4101501056 | 547x717x25 mm DX |
| 4101501057 | 547x717x25 mm SX |
| 4101501066 | 647x717x25 mm DX |
| 4101501067 | 647x717x25 mm SX |

Basi angolo

Corner cabinets

Ripiano per base angolo con supporti

Shelf for corner cabinet
with supports

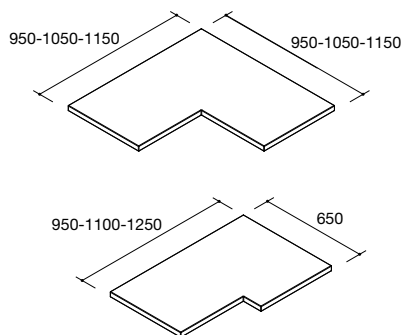

| CODICE/code | DIMENSIONI/size |
|-------------|-----------------|
| 4101101095 | 950x950 mm |
| 4101101096 | 950x650 mm DX |
| 4101101097 | 950x650 mm SX |
| 4101101105 | 1050x1050 mm |
| 4101101111 | 1100x650 mm DX |
| 4101101112 | 1100x650 mm SX |
| 4101101115 | 1150x1150 mm |
| 4101101126 | 1250x650 mm DX |
| 4101101127 | 1250x650 mm SX |

Angolare ante Standard

Standard angle bracket

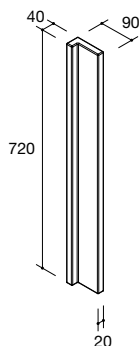

| CODICE/code | DIMENSIONI/size |
|-------------|------------------|
| 4100201901 | 40x40x20 H720 mm |
| 4100201902 | 90x40x20 H720 mm |

Angolare ante Gola

Molding angle bracket

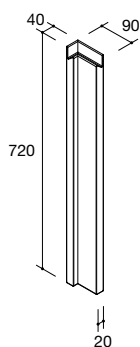

| CODICE/code | DIMENSIONI/size |
|-------------|------------------|
| 4100201910 | 40x40x25 H720 mm |
| 4100201911 | 90x40x25 H720 mm |
| 4100201912 | 90x40x25 H720 mm |

Colonne 450 mm

Columns 450 mm

Colonna H 2040 mm

Column H 2040 mm

H 120/150 mm piedini / feet

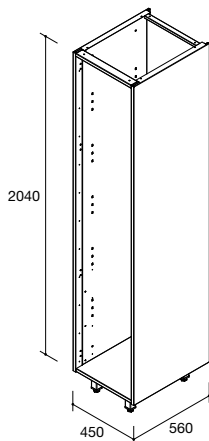

| CODICE/code | DIMENSIONI/size |
|-------------|-----------------|
| 4100301045 | 450x560x2040 mm |

Ripiano per colonna da 45 con supporti

Shelf for column 45 with supports

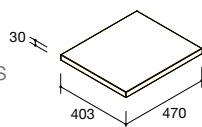

| CODICE/code | DIMENSIONI/size |
|-------------|-----------------|
| 4101101045 | 403x470x30 mm |

Anta Standard H 2037 mm

Standard door H 2037 mm

Anta montata con 4 cerniere
Blumotion 110°
Mounted door with 4 hinge
Blumotion 110°

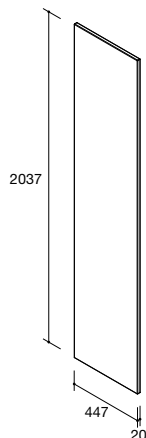

| CODICE/code | DIMENSIONI/size |
|-------------|-----------------|
| 4101201245 | 447x2037x20 mm |

Anta Gola H 2037 mm

Molding door H 2037 mm

Anta montata con 4 cerniere
Blumotion 110°
Mounted door with 4 hinge
Blumotion 110°

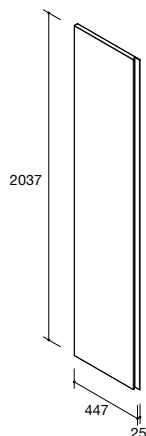

| CODICE/code | DIMENSIONI/size |
|-------------|-------------------|
| 4101301246 | 447x2037x25 mm DX |
| 4101301247 | 447x2037x25 mm SX |

Colonne 450 mm

Columns 450 mm

Anta Standard H 1317 mm

Standard door H 1317 mm

Anta montata con 3 cerniere
Blumotion 110°
Mounted door with 3 hinge
Blumotion 110°

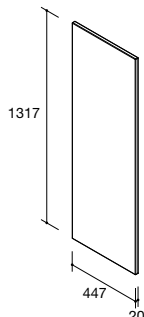

| CODICE/code | DIMENSIONI/size |
|-------------|-----------------|
| 4101201145 | 447x1317x20 mm |

Anta Gola H 1317 mm

Molding door H 1317 mm

Anta montata con 3 cerniere
Blumotion 110°
Mounted door with 3 hinge
Blumotion 110°

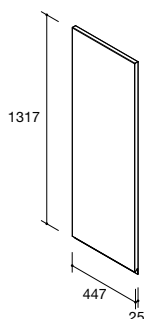

| CODICE/code | DIMENSIONI/size |
|-------------|-------------------|
| 4101301146 | 447x1317x25 mm DX |
| 4101301147 | 447x1317x25 mm SX |

Anta Standard H 717 mm

Standard door H 717 mm

Anta montata con 2 cerniere
Blumotion 110°
Mounted door with 2 hinge
Blumotion 110°

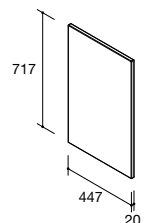

| CODICE/code | DIMENSIONI/size |
|-------------|-----------------|
| 4101201045 | 447x717x20 mm |

Anta Gola H 717 mm

Molding door H 717 mm

Anta montata con 2 cerniere
Blumotion 110°
Mounted door with 2 hinge
Blumotion 110°

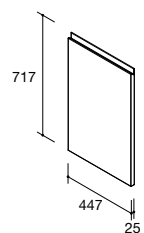

| CODICE/code | DIMENSIONI/size |
|-------------|------------------|
| 4101301046 | 447x717x25 mm DX |
| 4101301047 | 447x717x25 mm SX |

Cassetto Standard H 177 mm

Standard drawer H 177 mm

Cassetto montato inox
con guide "Blum" e frontale
Mounted drawer with blum
rails and front panel

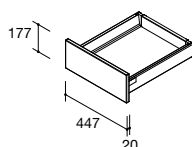

| CODICE/code | DIMENSIONI/size |
|-------------|-----------------|
| 4102201045 | 447x177x20 mm |

Cassetto Gola H 177 mm

Molding drawer H 177 mm

Cassetto montato inox
con guide "Blum" e frontale
Mounted drawer with blum
rails and front panel

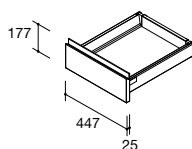

| CODICE/code | DIMENSIONI/size |
|-------------|-----------------|
| 4103101045 | 447x177x25 mm |

Colonne 450 mm

Columns 450 mm

Cestone Standard H 717 mm

Standard high fronted
pull-out H 717 mm

Cestone montato inox
con guide "Blum" e frontale
Mounted high fronted pull-out
with blum rails and front panel

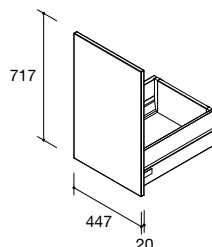

CODICE/code DIMENSIONI/size

4102501045 447x717x20 mm

Cestone Gola H 717 mm

Molding high fronted
pull-out H 717 mm

Cestone montato inox
con guide "Blum" e frontale
Mounted high fronted pull-out
with blum rails and front panel

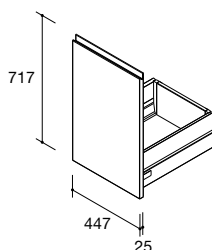

CODICE/code DIMENSIONI/size

4103401045 447x717x25 mm

Cestone Standard H 537 mm

Standard high fronted
pull-out H 537 mm

Cestone montato inox
con guide "Blum" e frontale
Mounted high fronted pull-out
with blum rails and front panel

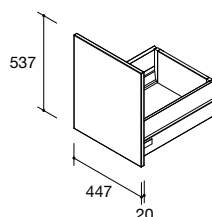

CODICE/code DIMENSIONI/size

4102401045 447x537x20 mm

Cestone Gola H 537 mm

Molding high fronted
pull-out H 537 mm

Cestone montato inox
con guide "Blum" e frontale
Mounted high fronted pull-out
with blum rails and front panel

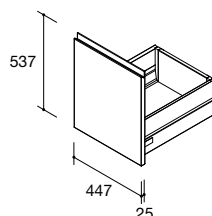

CODICE/code DIMENSIONI/size

4103301045 447x537x25 mm

Cestone Standard H 357 mm

Standard high fronted
pull-out H 357 mm

Cestone montato inox
con guide "Blum" e frontale
Mounted high fronted pull-out
with blum rails and front panel

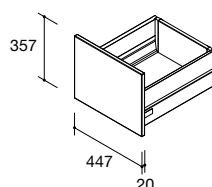

CODICE/code DIMENSIONI/size

4102301045 447x357x20 mm

Cestone Gola H 357 mm

Molding high fronted
pull-out H 357 mm

Cestone montato inox
con guide "Blum" e frontale
Mounted high fronted pull-out
with blum rails and front panel

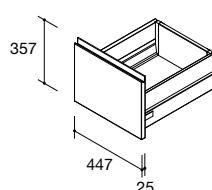

CODICE/code DIMENSIONI/size

4103201045 447x357x25 mm

Colonne 450 mm

Columns 450 mm

Ripiano fisso per colonna da 450

Fixed shelf for column 450

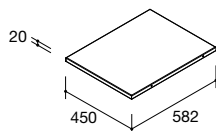

| CODICE/code | DIMENSIONI/size |
|-------------|-----------------|
| 4101101046 | 450x582x20 mm |

Cestone Interno

Inner high fronted pull-out

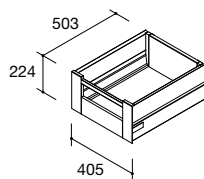

| CODICE/code | DIMENSIONI/size |
|-------------|-----------------|
| 4102701045 | 405x503x224 mm |

Piano per colonna anta Standard

Top for column with standard door

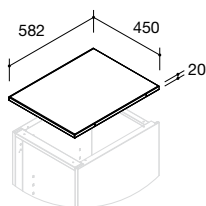

| CODICE/code | DIMENSIONI/size |
|-------------|-----------------|
| 4101101047 | 450x582x20 mm |

Piano per colonna anta Gola

Top for column with molding door

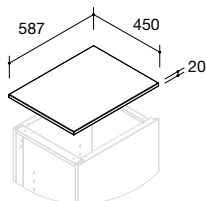

| CODICE/code | DIMENSIONI/size |
|-------------|-----------------|
| 4101101048 | 450x587x20 mm |

Colonne 600 mm

Columns 600 mm

Colonna H 2040 mm

Column H 2040 mm

H 120/150 mm piedini / feet

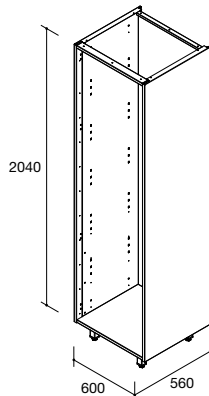

| CODICE/code | DIMENSIONI/size |
|-------------|-----------------|
| 4100301060 | 600x560x2040 mm |

Ripiano per colonna da 60 con supporti

Shelf for column 60 with supports

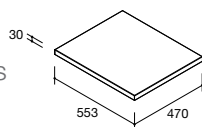

| CODICE/code | DIMENSIONI/size |
|-------------|-----------------|
| 4101101060 | 553x470x30 mm |

Anta Standard H 2037 mm

Standard door H 2037 mm

Anta montata con 4 cerniere
Blumotion 110°
Mounted door with 4 hinge
Blumotion 110°

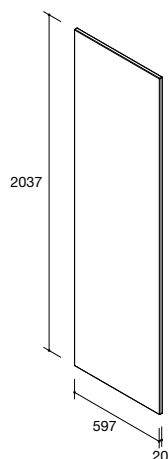

| CODICE/code | DIMENSIONI/size |
|-------------|-----------------|
| 4101201260 | 597x2037x20 mm |

Anta Gola H 2037 mm

Molding door H 2037 mm

Anta montata con 4 cerniere
Blumotion 110°
Mounted door with 4 hinge
Blumotion 110°

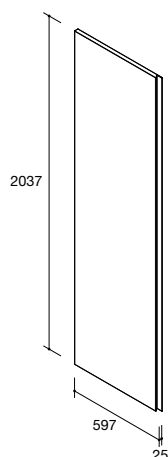

| CODICE/code | DIMENSIONI/size |
|-------------|-------------------|
| 4101301261 | 597x2037x25 mm DX |
| 4101301262 | 597x2037x25 mm SX |

Colonne 600 mm

Columns 600 mm

Anta Standard H 1317 mm

Standard door H 1317 mm

Anta montata con 3 cerniere
Blumotion 110°
Mounted door with 3 hinge
Blumotion 110°

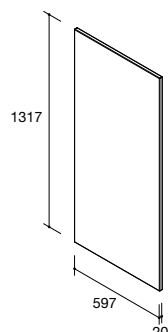

| CODICE/code | DIMENSIONI/size |
|-------------|-----------------|
| 4101201160 | 597x1317x20 mm |

Anta Gola H 1317 mm

Molding door H 1317 mm

Anta montata con 3 cerniere
Blumotion 110°
Mounted door with 3 hinge
Blumotion 110°

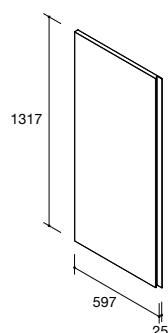

| CODICE/code | DIMENSIONI/size |
|-------------|-----------------|
| 4101301161 | 597x1317x25 mm |
| 4101301162 | 597x1317x25 mm |

Anta Standard H 717 mm

Standard door H 717 mm

Anta montata con 2 cerniere
Blumotion 110°
Mounted door with 2 hinge
Blumotion 110°

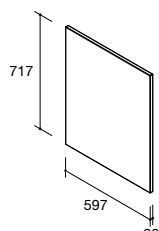

| CODICE/code | DIMENSIONI/size |
|-------------|-----------------|
| 4101201060 | 597x717x20 mm |

Anta Gola H 717 mm

Molding door H 717 mm

Anta montata con 2 cerniere
Blumotion 110°
Mounted door with 2 hinge
Blumotion 110°

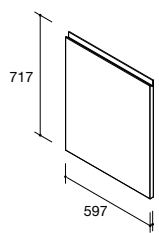

| CODICE/code | DIMENSIONI/size |
|-------------|------------------|
| 4101301061 | 597x717x25 mm DX |
| 4101301062 | 597x717x25 mm SX |

Cassetto Standard H 177 mm

Standard drawer H 177 mm

Cassetto montato inox
con guide "Blum" e frontale
Mounted drawer with blum
rails and front panel

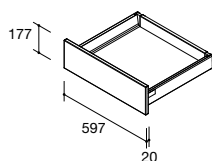

| CODICE/code | DIMENSIONI/size |
|-------------|-----------------|
| 4102201060 | 597x177x20 mm |

Cassetto Gola H 177 mm

Molding drawer H 177 mm

Cassetto montato inox
con guide "Blum" e frontale
Mounted drawer with blum
rails and front panel

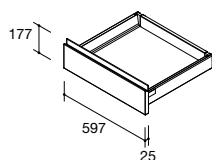

| CODICE/code | DIMENSIONI/size |
|-------------|-----------------|
| 4103101060 | 597x177x25 mm |

Colonne 600 mm

Columns 600 mm

Cestone Standard H 537 mm

Standard high fronted pull-out H 537 mm

Cestone montato inox con guide "Blum" e frontale
Mounted high fronted pull-out with blum rails and front panel

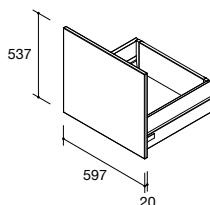

| CODICE/code | DIMENSIONI/size |
|-------------|-----------------|
| 4102401060 | 597x537x20 mm |

Cestone Gola H 537 mm

Molding high fronted pull-out H 537 mm

Cestone montato inox con guide "Blum" e frontale
Mounted high fronted pull-out with blum rails and front panel

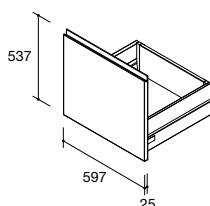

| CODICE/code | DIMENSIONI/size |
|-------------|-----------------|
| 4103301060 | 597x537x25 mm |

Cestone Standard H 357 mm

Standard high fronted pull-out H 357 mm

Cestone montato inox con guide "Blum" e frontale
Mounted high fronted pull-out with blum rails and front panel

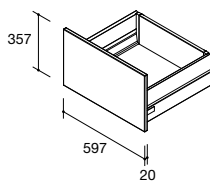

| CODICE/code | DIMENSIONI/size |
|-------------|-----------------|
| 4102301060 | 597x357x20 mm |

Cestone Gola H 357 mm

Molding high fronted pull-out H 357 mm

Cestone montato inox con guide "Blum" e frontale
Mounted high fronted pull-out with blum rails and front panel

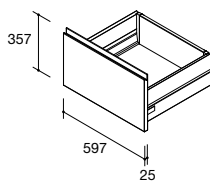

| CODICE/code | DIMENSIONI/size |
|-------------|-----------------|
| 4103201060 | 597x357x25 mm |

Ripiano fisso per colonna da 600

Fixed shelf for column 600

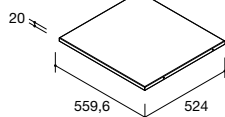

| CODICE/code | DIMENSIONI/size |
|-------------|-----------------|
| 4101101061 | 559,6x524x20 mm |

Cestone Interno

Inner high fronted pull-out

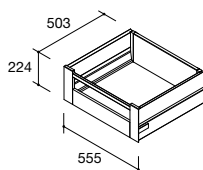

| CODICE/code | DIMENSIONI/size |
|-------------|-----------------|
| 4102701060 | 555x503x224 mm |

Colonne 600 mm

Columns 600 mm

Piano per colonna anta Standard

Top for column with standard door

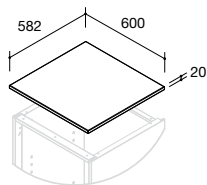

| CODICE/code | DIMENSIONI/size |
|-------------------|-----------------|
| 4101101062 | 600x582x20 mm |

Piano per colonna anta Gola

Top for column with molding door

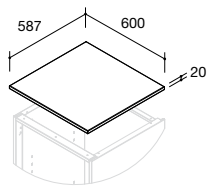

| CODICE/code | DIMENSIONI/size |
|-------------------|-----------------|
| 4101101063 | 600x587x20 mm |

Pensili con ante a battente H 600 mm

Wall cabinets with shutter doors H 600 mm

Pensile 450 mm

Wall cabinet 450 mm

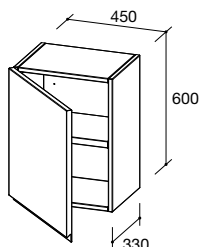

| CODICE/code | DESCRIZIONE/description | DIMENSIONI/size |
|-------------|---|--------------------|
| 4104201045 | Pensile Wall cabinet | L 450x330 H 600 mm |
| 4105101045 | Ripiano per pensile con supporti Shelf for wall cabinet with support | L 403x296 H 30 mm |
| 4101201345 | Anta montata standard con cerniere Mounted standard door with hinges | L 447x597 H 20 mm |
| 4101301348 | Anta montata Gola DX con cerniere Right molding door mounted with hinges | L 447x597 H 25 mm |
| 4101301349 | Anta montata Gola SX con cerniere Left molding door mounted with hinges | L 447x597 H 25 mm |

Pensile 600 mm

Wall cabinet 600 mm

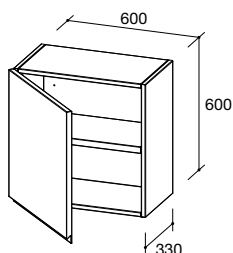

| CODICE/code | DESCRIZIONE/description | DIMENSIONI/size |
|-------------|---|--------------------|
| 4104201060 | Pensile Wall cabinet | L 600x330 H 600 mm |
| 4105101060 | Ripiano per pensile con supporti Shelf for wall cabinet with support | L 553x296 H 30 mm |
| 4101201360 | Anta montata standard con cerniere Mounted standard door with hinges | L 597x597 H 20 mm |
| 4101301363 | Anta montata Gola DX con cerniere Right molding door mounted with hinges | L 597x597 H 25 mm |
| 4101301364 | Anta montata Gola SX con cerniere Left molding door mounted with hinges | L 597x597 H 25 mm |

Pensile 900 mm

Wall cabinet 900 mm

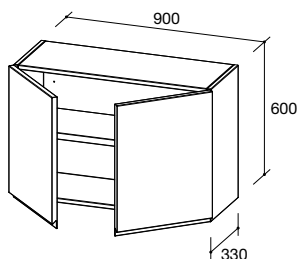

| CODICE/code | DESCRIZIONE/description | DIMENSIONI/size |
|-------------|---|--------------------|
| 4104201090 | Pensile Wall cabinet | L 900x330 H 600 mm |
| 4105101090 | Ripiano per pensile con supporti Shelf for wall cabinet with support | L 853x296 H 30 mm |
| 4101201345 | Anta montata standard con cerniere Mounted standard door with hinges | L 447x597 H 20 mm |
| 4101301348 | Anta montata Gola DX con cerniere Right molding door mounted with hinges | L 447x597 H 25 mm |
| 4101301349 | Anta montata Gola SX con cerniere Left molding door mounted with hinges | L 447x597 H 25 mm |

Pensile 1200 mm

Wall cabinet 1200 mm

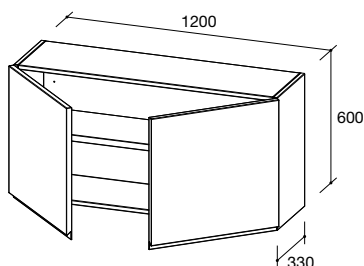

| CODICE/code | DESCRIZIONE/description | DIMENSIONI/size |
|-------------|---|---------------------|
| 4104201120 | Pensile Wall cabinet | L 1200x330 H 600 mm |
| 4105101120 | Ripiano per pensile con supporti Shelf for wall cabinet with support | L 1153x296 H 30 mm |
| 4101201360 | Anta montata standard con cerniere Mounted standard door with hinges | L 597x597 H 20 mm |
| 4101301363 | Anta montata Gola DX con cerniere Right molding door mounted with hinges | L 597x597 H 25 mm |
| 4101301364 | Anta montata Gola SX con cerniere Left molding door mounted with hinges | L 597x597 H 25 mm |

Pensili con ante a battente H 720 mm

Wall cabinets with shutter doors H 720 mm

Pensile 450 mm

Wall cabinet 450 mm

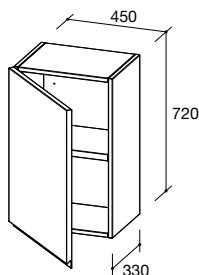

| CODICE/code | DESCRIZIONE/description | DIMENSIONI/size |
|-------------|---|--------------------|
| 4104301045 | Pensile Wall cabinet | L 450x330 H 720 mm |
| 4105101045 | Ripiano per pensile con supporti Shelf for wall cabinet with support | L 403x296 H 30 mm |
| 4101201045 | Anta montata standard con cerniere Mounted standard door with hinges | L 447x717 H 20 mm |
| 4101301048 | Anta montata Gola DX con cerniere Right molding door mounted with hinges | L 447x717 H 25 mm |
| 4101301049 | Anta montata Gola SX con cerniere Left molding door mounted with hinges | L 447x717 H 25 mm |

Pensile 600 mm

Wall cabinet 600 mm

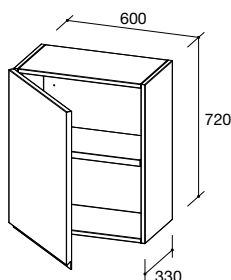

| CODICE/code | DESCRIZIONE/description | DIMENSIONI/size |
|-------------|---|--------------------|
| 4104301060 | Pensile Wall cabinet | L 600x330 H 720 mm |
| 4105101060 | Ripiano per pensile con supporti Shelf for wall cabinet with support | L 553x296 H 30 mm |
| 4101201060 | Anta montata standard con cerniere Mounted standard door with hinges | L 597x717 H 20 mm |
| 4101301063 | Anta montata Gola DX con cerniere Right molding door mounted with hinges | L 597x717 H 25 mm |
| 4101301064 | Anta montata Gola SX con cerniere Left molding door mounted with hinges | L 597x717 H 25 mm |

Pensile 900 mm

Wall cabinet 900 mm

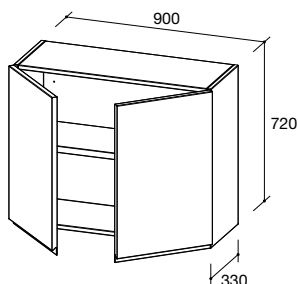

| CODICE/code | DESCRIZIONE/description | DIMENSIONI/size |
|-------------|---|--------------------|
| 4104301090 | Pensile Wall cabinet | L 900x330 H 720 mm |
| 4105101090 | Ripiano per pensile con supporti Shelf for wall cabinet with support | L 853x296 H 30 mm |
| 4101201045 | Anta montata standard con cerniere Mounted standard door with hinges | L 447x717 H 20 mm |
| 4101301048 | Anta montata Gola DX con cerniere Right molding door mounted with hinges | L 447x717 H 25 mm |
| 4101301049 | Anta montata Gola SX con cerniere Left molding door mounted with hinges | L 447x717 H 25 mm |

Pensile 1200 mm

Wall cabinet 1200 mm

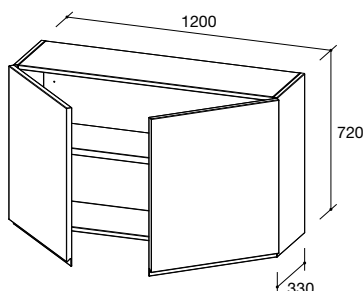

| CODICE/code | DESCRIZIONE/description | DIMENSIONI/size |
|-------------|---|---------------------|
| 4104301120 | Pensile Wall cabinet | L 1200x330 H 720 mm |
| 4105101120 | Ripiano per pensile con supporti Shelf for wall cabinet with support | L 1153x296 H 30 mm |
| 4101201060 | Anta montata standard con cerniere Mounted standard door with hinges | L 597x717 H 20 mm |
| 4101301063 | Anta montata Gola DX con cerniere Right molding door mounted with hinges | L 597x717 H 25 mm |
| 4101301064 | Anta montata Gola SX con cerniere Left molding door mounted with hinges | L 597x717 H 25 mm |

Pensili con ante a basculanti H 600 mm

Wall cabinets with folding doors H 600 mm

Pensile 450 mm

Wall cabinet 450 mm

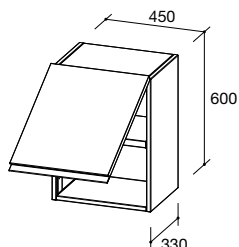

| CODICE/code | DESCRIZIONE/description | DIMENSIONI/size |
|-------------|---|--------------------|
| 4104201045 | Pensile Wall cabinet | L 450x330 H 600 mm |
| 4105101045 | Ripiano per pensile con supporti Shelf for wall cabinet with support | L 403x296 H 30 mm |
| 4105201145 | Anta basculante standard montata Mounted standard door | L 447x597 H 20 mm |
| 4105301145 | Anta basculante Gola montata Mounted molding door | L 447x597 H 25 mm |

Pensile 600 mm

Wall cabinet 600 mm

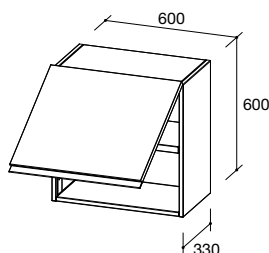

| CODICE/code | DESCRIZIONE/description | DIMENSIONI/size |
|-------------|---|--------------------|
| 4104201060 | Pensile Wall cabinet | L 600x330 H 600 mm |
| 4105101060 | Ripiano per pensile con supporti Shelf for wall cabinet with support | L 553x296 H 30 mm |
| 4105201160 | Anta basculante standard montata Mounted standard door | L 597x597 H 20 mm |
| 4105301160 | Anta basculante Gola montata Mounted molding door | L 597x597 H 25 mm |

Pensile 900 mm

Wall cabinet 900 mm

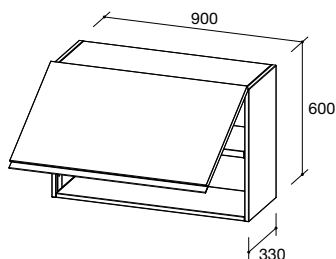

| CODICE/code | DESCRIZIONE/description | DIMENSIONI/size |
|-------------|---|--------------------|
| 4104201090 | Pensile Wall cabinet | L 900x330 H 600 mm |
| 4105101090 | Ripiano per pensile con supporti Shelf for wall cabinet with support | L 853x296 H 30 mm |
| 4105201190 | Anta basculante standard montata Mounted standard door | L 897x597 H 20 mm |
| 4105301190 | Anta basculante Gola montata Mounted molding door | L 897x597 H 25 mm |

Pensili con ante a basculanti H 360 mm

Wall cabinets with folding doors H 360 mm

Pensile 450 mm

Wall cabinet 450 mm

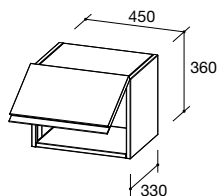

| CODICE/code | DESCRIZIONE/description | DIMENSIONI/size |
|-------------|---|--------------------|
| 4104101045 | Pensile Wall cabinet | L 450x330 H 360 mm |
| 4105201045 | Anta basculante standard montata Mounted standard door | L 447x357 H 20 mm |
| 4105301045 | Anta basculante Gola montata Mounted molding door | L 447x357 H 25 mm |

Pensile 600 mm

Wall cabinet 600 mm

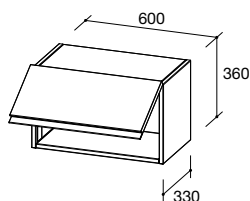

| CODICE/code | DESCRIZIONE/description | DIMENSIONI/size |
|-------------|---|--------------------|
| 4104101060 | Pensile Wall cabinet | L 600x330 H 360 mm |
| 4105201060 | Anta basculante standard montata Mounted standard door | L 597x357 H 20 mm |
| 4105301060 | Anta basculante Gola montata Mounted molding door | L 597x357 H 25 mm |

Pensile 900 mm

Wall cabinet 900 mm

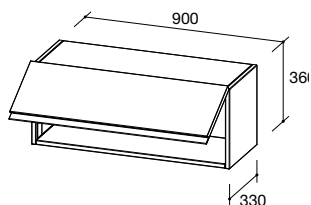

| CODICE/code | DESCRIZIONE/description | DIMENSIONI/size |
|-------------|---|--------------------|
| 4104101090 | Pensile Wall cabinet | L 900x330 H 360 mm |
| 4105201090 | Anta basculante standard montata Mounted standard door | L 897x357 H 20 mm |
| 4105301090 | Anta basculante Gola montata Mounted molding door | L 897x357 H 25 mm |

Pensile 1200 mm

Wall cabinet 1200 mm

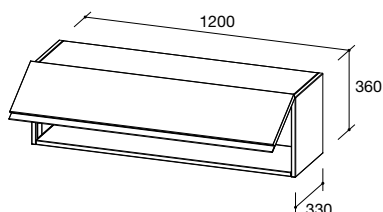

| CODICE/code | DESCRIZIONE/description | DIMENSIONI/size |
|-------------|---|---------------------|
| 4104101120 | Pensile Wall cabinet | L 1200x330 H 360 mm |
| 4105201120 | Anta basculante standard montata Mounted standard door | L 1197x357 H 20 mm |
| 4105301120 | Anta basculante Gola montata Mounted molding door | L 1197x357 H 25 mm |